

Troop 1292 #148A

MERIT BADGE SERIES



# WELDING



BOY SCOUTS OF AMERICA

## HOW TO USE THIS PAMPHLET

The secret to successfully earning a merit badge is for you to use both the pamphlet and the suggestions of your counselor.

Your counselor can be as important to you as a coach is to an athlete. Use all of the resources your counselor can make available to you. This may be the best chance you will have to learn about this particular subject. Make it count.

If you or your counselor feels that any information in this pamphlet is incorrect, please let us know. Please state your source of information.

Merit badge pamphlets are reprinted annually and requirements updated regularly. Your suggestions for improvement are welcome.

Send comments along with a brief statement about yourself to Youth Development, S209 • Boy Scouts of America • 1325 West Walnut Hill Lane • P.O. Box 152079 • Irving, TX 75015-2079.

## WHO PAYS FOR THIS PAMPHLET?

This merit badge pamphlet is one in a series of more than 100 covering all kinds of hobby and career subjects. It is made available for you to buy as a service of the national and local councils, Boy Scouts of America. The costs of the development, writing, and editing of the merit badge pamphlets are paid for by the Boy Scouts of America in order to bring you the best book at a reasonable price.



BOY SCOUTS OF AMERICA  
MERIT BADGE SERIES

# WELDING



BOY SCOUTS OF AMERICA®

## Note to the Counselor

The Welding merit badge must be taught by a qualified person who is highly experienced in welding and is knowledgeable about various types of welding processes, specifically oxyacetylene welding, shielded metal arc welding, gas metal arc welding, and flux-cored arc welding.

The Welding merit badge offers Scouts an opportunity to learn four welding processes commonly used in industrial workshops and in home “garage” shops. Home versions of the equipment your Scouts will need can usually be found without a great investment. Portable versions for field use during Scout outings can sometimes be found, as well. During summer camp, compact electrical welding equipment can be powered from a simple 120-volt circuit or from a portable generator or self-contained power supply. If you are using oxy-fuel welding equipment, be aware that it is not powered by electricity.

You are encouraged to enrich each Scout’s experience by drawing upon your professional knowledge and expertise. However, only the methods, techniques, and materials discussed in this book as appropriate for the Welding merit badge should be attempted. Keep in mind that as a merit badge counselor, you may not add or delete requirements, or change them to make them simpler or more difficult. If a Scout develops an enhanced interest in welding and wants to further his skills beyond the level of this booklet, encourage him to pursue additional training. Many high schools, community colleges, technical schools, and union halls offer training opportunities in welding to students who are of appropriate age and ability level.

35974  
ISBN 978-0-8395-3430-3  
©2012 Boy Scouts of America  
2012 Printing

BANG/Brainerd, MN  
2-2012/062495

Scouts who are pursuing the Welding merit badge will require direct adult supervision. They will be working with molten metals, electric arcs, welding fumes, and power tools that, if misused, can cause serious injury. Personal protective equipment including eye protection, hearing protection, heavy gloves, and sturdy footwear must be in use at all times when Scouts are welding. There are no exceptions.



See the *First Aid, Composite Materials, Home Repairs, Woodwork, Emergency Preparedness,* and *Safety* merit badge pamphlets and the BSA Scouting Safely web page for more information about safety, first aid, and managing risks. The “Health and Safety” chapter includes a useful checklist for a welder’s first-aid kit.

# Requirements

1. Do the following:
  - a. Explain to your counselor the hazards you are most likely to encounter while welding, and what you should do to anticipate, help prevent, mitigate, or lessen these hazards.
  - b. Show that you know first aid for, and the prevention of, injuries or illnesses that could occur while welding, including electrical shock, eye injuries, burns, fume inhalation, dizziness, skin irritation, and exposure to hazardous chemicals, including filler metals and welding gases.
2. Do the following:
  - a. With your counselor, discuss general safety precautions and Material Safety Data Sheets related to welding. Explain the importance of the MSDS.
  - b. Describe the appropriate safety gear and clothing that must be worn when welding. Then, present yourself properly dressed for welding—in protective equipment, clothing, and footwear.
  - c. Explain and demonstrate the proper care and storage of welding equipment, tools, and protective clothing and footwear.
3. Explain the terms *welding*, *electrode*, *slag*, and *oxidation*. Describe the welding process, how heat is generated, what kind of filler metal is added (if any), and what protects the molten metal from the atmosphere.
4. Name the different mechanical and thermal cutting methods. Choose one method and describe how to use the process. Discuss one advantage and one limitation of this process.
5. Do the following:
  - a. Select two welding processes, and make a list of the different components of the equipment required for each process. Discuss one advantage and one limitation for each process.
  - b. Choose one welding process. Set up the process you have chosen, including gas regulators, work clamps, cables, filler materials, and equipment settings. Have your counselor inspect and approve the area for the welding process you have chosen.
6. After successfully completing requirements 1 through 5, use the equipment you prepared for the welding process in 5b to do the following:
  - a. Using a metal scribe or soapstone, sketch your initial onto a metal plate, and weld a bead on the plate following the pattern of your initial.
  - b. Cover a small plate (approximately 3" x 3" x ¼") with weld beads side by side.
  - c. Tack two plates together in a square groove butt joint.
  - d. Weld the two plates together from 6c on both sides.
  - e. Tack two plates together in a T joint, have your counselor inspect it, then weld a T joint with fillet weld on both sides.
  - f. Tack two plates together in a lap joint, have your counselor inspect it, then weld a lap joint with fillet weld on both sides.
7. Do the following:
  - a. Find out about three career opportunities in the welding industry. Pick one and find out the education, training, and experience required for this profession. Discuss this with your counselor, and explain why the profession might interest you.
  - b. Discuss the role of the American Welding Society in the welding profession.





## Contents

What Is Welding? .....	9
Health and Safety .....	11
Welding and Cutting Methods .....	29
Preparation for Welding and Cutting .....	51
Welding for the Novice .....	67
Careers in Welding .....	80
Glossary .....	82
Welding Resources .....	87

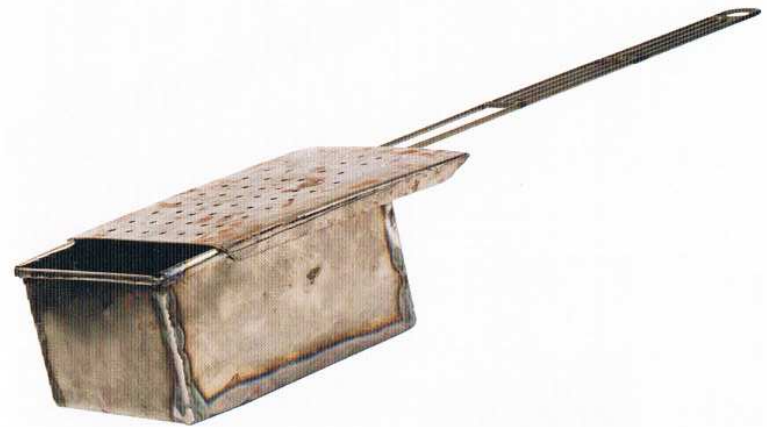



During World War II, the country depended heavily on women to fill roles traditionally held by men. These women arc welders worked at a plant that produced B-25 "Billy Mitchell" bombers and P-51 "Mustang" fighter planes.

## What Is Welding?

You may wonder what it means to weld. **Welding** is the process of joining with a weld—joining or combining similar pieces of **metal** by heating them with a flame torch or an **electric current**, then hammering or pressing them together while they are soft. Welding can also be done by melting plastic or metal into the **joint** of a similar material. The temperature range for welding is 3,000 to 10,000 degrees Fahrenheit.

Welding plays a major role in our modern world, and mastery of the skill can lead to exciting career opportunities. Someday, you may have an opportunity to experience exciting new career paths in welding. There are more than 80 welding, cutting, and welding-related processes, only a few of which will be covered in this booklet.

Terms in boldface, like **welding**, can be found in the glossary at the back of this pamphlet.

The American Welding Society was formed in 1919 by 20 members



**American Welding Society**

of the Wartime Welding Committee of the Emergency Fleet Corporation under the leadership of Comfort Avery Adams. This nonprofit organization is dedicated to the advancement of welding and allied processes. It is also closely involved with setting safety standards within the industry.

Astronaut Buzz Aldrin, who was a Scout, gives credit to welders for helping him become one of the first humans to walk on the moon.



## Health and Safety

On the following pages, you will learn safety procedures to follow when **arc welding**.

### Staying Safe While Welding

Arc welding uses an electric current that generates intense heat and emits intense light, both extremely dangerous. It is essential that you thoroughly understand all safety precautions before you begin. Carelessness or ignoring safety practices can be damaging or even fatal to you and to anyone who is nearby.

Always read the warning labels for every piece of equipment or component and **filler metals** you use. If you are ever in doubt about a safety issue, ask your merit badge counselor. Let's take a look at some of the risks.

### Safety Basics

Arc welding, **oxy-fuel welding**, and **oxy-fuel cutting** all share one characteristic: The harmful and intense **infrared** and **ultraviolet rays** that are emitted by the welding process will damage unprotected eyes *and* exposed skin, kind of like getting a sunburn—only worse. When you are welding, you must *always* protect yourself. The information presented here will help you stay safe during welding activities.

**Always have a fire extinguisher nearby.** When welding, you must always be conscious of fire protection and keep a class ABC fire extinguisher within easy reach, mounted at shoulder level. Fire extinguishers should be checked monthly to ensure the tank is full and the pressure is normal. If anything appears out of the ordinary, replace the extinguisher or have it professionally serviced.

## Welder's First-Aid Kit

These items are typically found in a welder's first-aid kit, which is extensive and geared to treat burns, eye irritations, cuts, sprains, and common welder injuries.

- 32 adhesive bandages (1" x 3")
- 6 extra-large adhesive bandages
- 10 PVP iodine wipes
- 12 BZK antiseptic wipes
- 10 triple antibiotic individual packets
- 5 burn gel packets (1/8 oz.)
- 1 Foille® burn ointment (1/2-oz. tube)
- 1 burn dressing
- 10 sterile dressing pads (3" x 3")
- 4 sterile oval eye pads
- Eye wash solution (three 1/2-oz. bottles)
- 2 sterile combine pads (5" x 9")
- 1 triangular bandage with pins (40" x 40" x 56")
- 1 sterile conforming gauze bandage (3")
- 1 instant cold pack
- 1 spool of adhesive tape (1/2" x 5 yards)
- 1 pair of bandage scissors (steel, 5 1/2")
- 8 nonlatex vinyl gloves (large)
- 1 pair of forceps
- First-aid manual (such as one from the American Red Cross)

A class ABC fire extinguisher is a multipurpose, dry-chemical extinguisher useful for a welding environment. If you ever need to use an extinguisher, make sure you are between the fire and an exit. If the fire can't be controlled, you need a quick way out. For more information about fire extinguishers, see the *Fire Safety* merit badge pamphlet.



**Button up and wear the proper clothing for protection from UV and infrared rays.** Long-sleeved shirts of tightly woven, 100 percent wool (never synthetic fabrics) with buttoned cuffs and a collar (no pockets) provide the best protection from UV and infrared radiation, flying sparks, hot or melted metal, and flames. Wear pants with no cuffs (which can collect sparks and hot metal), and do not tuck pants into boots or shoes. It is best to wear dark colors, which will not reflect as much light as light-colored clothing. Wear a cap to help protect your head.

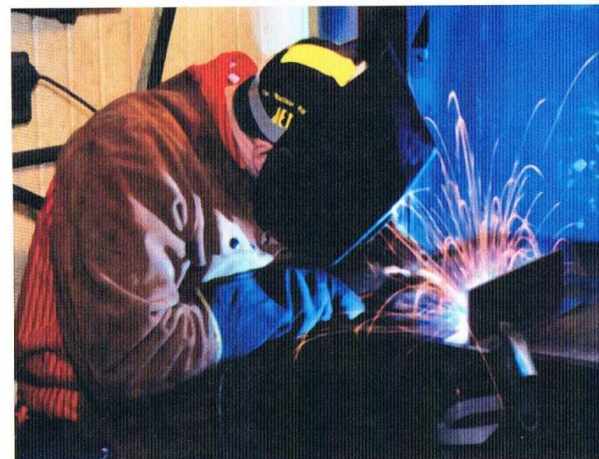

**A fully protected welder wears the proper clothing along with a welding helmet and leather sleeves, gloves, and shoes or boots. Wearing protective leather clothing minimizes the risk of fire and burns from spatter. Store leather garments in a well-ventilated area.**

It takes only one spark to start a fire. Be aware of the location of fire alarms and evacuation routes. Thoroughly inspect your entire area before beginning a weld.



**Spatter** (liquid metal droplets) can spray up to 35 feet from the work area. These sparks can quickly start a fire if they touch **flammable material**. That is why welders must wear only certain types of clothing. Wearing proper clothing will also help prevent most welding-related burns. Clothing and shoes made from synthetic fabrics like polyester or rayon can melt from the arc's extreme heat, causing severe burns.

Clean clothing, free of grease and other contaminants, is less likely to catch fire than dirty, greasy clothing.

Wear close-fitting clothing. Loose or baggy clothes can easily get caught in machinery.



Dark clothing helps protect a welder from the arc's harmful rays. Wool offers the best protection, but heavy cotton will do. For added safety, wear another layer of any of these: leather welding jacket, trousers, aprons, sleeves, or bibs.

During arc welding, **never roll up your sleeves or cuff your pants**. All clothing should be completely buttoned with no frays or tatters. It's best to wear a shirt that has no pockets. If your shirt has pockets, close, button, or tape them shut to prevent sparks from falling into them.

During welding, any exposed skin may get burned from spatter and UV rays. Always protect yourself.

**Wear flame-resistant leather gloves.** Keep your welding gloves dry, and check them for tears and rips. Take care of your gloves. If leather welding gloves get too close to excessive heat, they will shrink and distort, making them uncomfortable and eventually unusable.

**Wear the proper footwear.** Fully laced high-top boots provide the best protection. Keep them dry. Because sparks can fall into low-top shoes, wear smooth-top leather work boots, preferably with steel toes. Wear pants outside your work boots to prevent sparks from falling into your boots. Store boots in a clean, dry area.

**Never handle hot metal!** Welding gloves are not intended for handling hot metal. Use pliers or vise grips when handling parts that have just been welded.

**Do not leave any skin exposed.** A **welding helmet** or welding shield is designed to protect your eyes and face from the arc's harmful rays and intense light. You must wear face and eye protection during any welding process. Tinted glasses with proper shade, or goggles must be used with gas welding and cutting.

Never handle hot metal!



Safe welding starts with the proper attire.



Protecting yourself is the first step in safe welding.

When welding, always wear a face shield and protective clothing.



**Always wear eye protection when you are welding or when you are near anyone else who is welding. Welder's flash**, also described as sunburn on the eye, is known to doctors as photokeratitis. It is caused by exposure to the ultraviolet radiation given off by the welding arc. This affliction can cause extreme pain, swelling, fluid secretion, and temporary blindness. Usually, symptoms will begin to be felt several hours after exposure. Do not let this happen to you. Prevent injury from welder's flash by always wearing eye protection when you are welding or when you are near any welding activity.

If you have been welding and your eyes feel sunburned or you are having difficulty seeing, seek a doctor's care immediately. Welder's flash is usually a temporary condition, but repeated exposure can lead to permanent injury. Protect yourself from the arc's harmful rays by always wearing proper protective equipment for welding and cutting.

**Remove all jewelry (watches, rings, etc.) before welding.** Since you will be working around electricity and very high temperatures, wearing jewelry and watches is out of the question.

**Keep the welding area neat and clean.** With flying sparks, anything flammable will pose a fire hazard. Remove all flammable materials, trash, and any potential fire hazard.

**Always be aware of others in the welding area.** Onlookers must be protected, either with a **welding screen** or handheld **face shield**, depending on how near they are to the welding activity. They should maintain a proper distance from the arc and have adequate protection.

Even after you have finished welding, if you and others remain in the work area, you must continue to wear eye protection with side shields because of the risk of flying sparks or debris, especially while chipping **slag** (the solidified **flux** that forms on the weld bead) from a **workpiece**.

## Protect Your Eyes

Something in the eye is not just painful—it could endanger your eyesight. For protection, always wear safety goggles and additional protective equipment as needed when welding or in an area where others are welding. Protective eyewear will also keep harmful **fumes** and vapors from hurting your eyes.

If a foreign object gets in your eye, do not rub the eye; rubbing might scratch the cornea (the clear covering of the colored part of the eye). Blink your eyes; tears might flush out the object. If that doesn't work, wash your hands with soap and water, then try to flush out the particles with clean running water or clean water poured from a glass or bottle.

Foreign matter that is embedded in the eye or that will not wash out must be treated by a physician. Stabilize the object if possible and cover the injured eye with a dry, sterile gauze pad. Seek immediate medical attention.



Handheld face shield commonly used by onlookers



Always wear a welding helmet for protection from the arc's dangerously bright light and harmful rays. Be sure your helmet has no cracks or breaks that could let light inside. Always use a plastic cover inside and outside of the lens to protect the filter lens. If the plastic cover lens becomes excessively scratched or dirty, remove and/or replace it.

Guide for Shade Numbers

Operation	Electrode Size ½ Inch (mm)	Arc Current (A)	Minimum Protective Shade	Suggested Shade No. (Comfort)
Shielded metal arc welding	<3 (2.5)	<60	7	—
	3–5 (2.5–4)	60–160	8	10
	5–8 (4–6.4)	160–250	10	12
	>8 (6.4)	250–500	11	14
Gas Metal Arc Welding and Flux Cored Arc Welding		<60	7	—
		60–160	10	11
		160–250	10	12
		250–500	10	14
Gas tungsten arc welding and plasma arc cutting		<50	8	10
		50–150	8	12
		150–500	10	14
Oxy-fuel gas welding	Plate thickness <¼"	Plate thickness <3mm		4 or 5
	¼"–½"	3–13mm		5 or 6
	>½"	>13mm		6 or 8
Oxy-fuel gas cutting	Plate thickness <1"	Plate thickness <25mm		3 or 4

#### Proper filter lens shading for arc welding

The chart shows the appropriate shading for arc welding processes. Begin with the darkest shade recommended for the process you are using; then move one shade lighter at a time until you find the most comfortable one while still adhering to the standard. Auto-darkening **welding shields** that automatically darken when the arc is struck are also available.

#### Always wear an approved welding helmet while welding.

Wearing a welding helmet allows you to safely view the arc through a window with a **filter plate** that removes damaging rays and light. The filter plate is protected from spatter and debris by a clear lens made of plastic or glass. Filter plates are available in various shades, ranging from darker to lighter. The higher the shade's number, the more shading it provides.

The American Welding Society sets the safety standards for the amount of shading needed for any welding process. The shade you use is specific to the welding process, the amount of **amperage**, and the size of **electrode** you use.



#### Always read all warning labels on arc welding components and filler metals container.

Prevention goes hand in hand with mitigation, which means "to lessen in force or intensity" and "to make less severe." By taking precautions to manage risk and the possibility of injury, you can be prepared to anticipate, help prevent, mitigate, and respond to just about any incident that might happen while welding.

#### Risk of Burns and Fire

The electric arc is extremely hot. Temperatures can reach 10,000 degrees Fahrenheit or higher. Exposure to this intense heat poses an extreme risk of burns or of starting a fire from the spatter.

Be sure your work area is free of **combustible** and flammable materials, including gas, oil, and grease, and that these materials are at least 35 feet from any welding activity. Commonly ignited substances are trash, wood, fabric, boxes, papers, rags, plastics, and chemicals. If you are welding in a

For more information about burns, see the *First Aid* merit badge pamphlet.



Leather high-top work boots will help protect your ankles and feet.

questionable area, place **fire shields** or flame-resistant blankets around the welding area, and have a responsible **fire watcher** keep watch for you. Continue inspecting for fire for 30 minutes after welding.

**First Aid for Thermal Burns.** *Superficial burns* are mild burns that affect only the outer layer of skin. Treat them by holding the burn under cold water or applying cool, wet compresses until the pain eases. *Partial-thickness burns* are more serious than superficial burns and affect the outer layer of skin and part of the layer of skin below it. They typically include a reddening and blistering of the skin. To treat such burns, first remove the person from the source of the burn. Cool the burned area with cold, running water until the pain is relieved. Let the burn dry, then protect it with a loosely applied, sterile gauze pad and bandage.

*Full-thickness burns* are very serious. They destroy the outer layer of skin and the layer below it. A victim who has been exposed to open flames, electricity, or chemicals may sustain full-thickness burns. The skin may be burned away and the flesh charred. If nerves are damaged, the victim may feel no pain. Such burns constitute a medical emergency. Do not try to remove any clothing, as it may be sticking to the victim's flesh. After cooling the burn, cover the burned area with dry, sterile dressings. **Seek immediate medical attention.**

### Risk of Electrical Shock

One of the most serious risks to the welder is **electrical shock**. An electrical shock of more than 30 volts can be fatal. Arc welding presents the risk of both **primary voltage shock** and **secondary voltage shock**. Primary voltage shock occurs when the power is on and someone simultaneously touches a **lead** inside the welding machine and either the welding machine or other grounded metal. The **shock** can be between 120 and 480 volts.

Secondary voltage shock will occur if you touch the electrode while another part of your body touches the workpiece. If you touch both of these components at the same time, you will receive an **electrical shock** ranging from 60 to 100 volts. The higher the voltage in an electrical circuit, the more serious the electrical shock will be.

Always remember that electricity easily flows through water. Therefore, when you are arc welding, you must stay dry. Never weld with wet gloves. *Even wetness from perspiration is dangerous.* Wear proper welding clothing to maintain **insulation** between yourself and your work.

Before you begin welding, be sure your work area is clean and dry. Inspect all of the equipment you will be using. Cables, electrodes, and **electrode holders** must be dry and in good condition. Ask your counselor to make a visual inspection and to replace any damaged components. Do not attempt to repair a welding machine yourself.



Be aware of risks at every stage of the welding process.

The shielded metal arc welding electrode holder must be dry.



Always keep your welding work area clean and dry.

When welding, stay safe and stay dry—never stand on a wet floor and never wear jewelry.



Never touch the electrode or metal parts of the electrode holder with skin or wet clothing. Never rest your body on the workpiece. Welding in or on the workpiece in damp or wet conditions will increase the risk of electrical shock.

Always remember that even though the welder is in the "off" position, a charge still exists inside the machine. Never open the housing of a welder without supervision by a trained technician.



**First Aid for Electrical Shock.** If electricity travels through a part of your body, you can get an electrical burn. Besides a burn, too much electricity can even stop the heart from beating correctly or damage other internal organs. Superficial and partial-thickness burns from electricity look like burns from too much heat; the skin may look charred. Full-thickness electrical burns may not leave charred skin. Instead, the skin can look leathery and white and be hard to the touch. Call 911 or the local emergency-response number if someone has an electrical burn.

Never touch a person who is in contact with a live electrical power source. If you encounter a victim of an electrical burn, shut off the power at its source and call an ambulance immediately.

#### Risks of Harmful Fume Inhalation

The welding process can emit dangerous fumes. A visible, smokelike cloud, known as the **fume plume**, arises directly from the point of welding. The fume plume is never safe to breathe. Long-term and short-term exposure may lead to severe respiratory and skin problems. The fume plume contains metallic vapors that have condensed into tiny particles of solid metal. These particles are suspended in the air and can settle on the walls and floor of the work area. Always protect yourself from the fume plume by wearing protective clothing and headgear. **Do not ever place your head directly into the fume plume.**

When welding with most mild steel electrodes with clean materials, if you are comfortable and can breathe easily, and the air is visibly clear, you probably have adequate ventilation. However, if you have a headache, chest pains, feel dizzy or nauseous, or have trouble breathing, turn off your welder, seek fresh air immediately, and notify your merit badge counselor. Also take note if you are pale, your eyes are tearing, or you feel a burning sensation around the lips, tongue, or on the skin. Seek medical attention.



Never inhale the gases of the fume plume.

All welding areas must have good **ventilation**. Air must be allowed to circulate without blockages such as dividing walls or equipment. Good ventilation can be supplemented with fans or **exhausts** that will direct fumes away from your face. Always keep your head away from the fume plume.

Some filler metals can produce toxic fumes when used in welding, which is why it is important to keep the area well ventilated. Anyone who becomes overwhelmed by fumes should seek fresh air and loosen tight clothing at the neck and waist for easier breathing. Seek immediate medical attention. It is important to let medical personnel know the contaminants that might have been released at the workplace.

**Good ventilation and a safety-approved welding helmet are essentials in protecting yourself from the fume plume.**



### Risk of Explosion

The **shielding** gases used in arc welding are commonly **inert** or only slightly reactive. However, the cylinders that contain these gases are under intense pressure. Always handle cylinders with care. Do not heat or weld on a cylinder.

Above all, learn about the materials you are welding and know the risks involved when working with them. Make sure you have the correct **base metals**, electrode, and shielding gases. This information can be found in the chapter "Welding and Cutting Methods." Never weld near flammable or combustible materials. Notify your merit badge counselor if you detect any damage to your welding equipment.



When using shielding gas, always observe safety precautions.

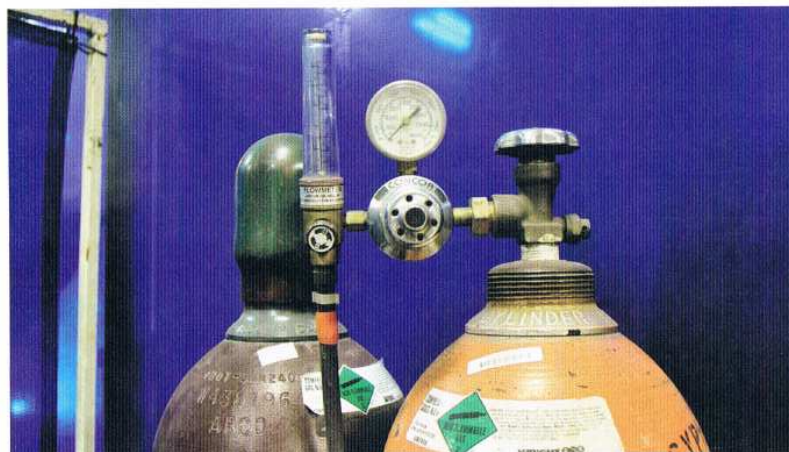

Exercise great caution when attaching a regulator to a cylinder.

### Material Safety Data Sheets

Material Safety Data Sheets are available for the filler materials you may be using. The MSDS gives the proper procedures for working with, handling, storing, and disposing of materials. The MSDS will also alert the user to any hazardous substances the product may contain, such as a hazardous material in a particular welding rod or that could evolve during welding with a particular welding rod.

Information about health and safety procedures is available from the American Welding Society, OSHA, and the National Institute for Occupational Safety and Health. Guidelines, definitions, and facts that will help you learn how to remain safe while welding can be downloaded free of charge from the AWS at [www.aws.org/technical/facts](http://www.aws.org/technical/facts). Also check out "Safety in Welding, Cutting, and Allied Processes," No. ANSIZ49.1, which can be found at [www.aws.org/safety](http://www.aws.org/safety).

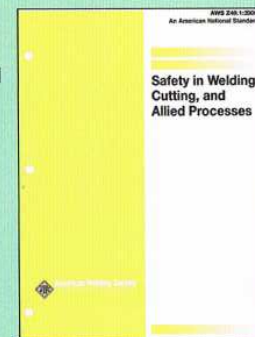

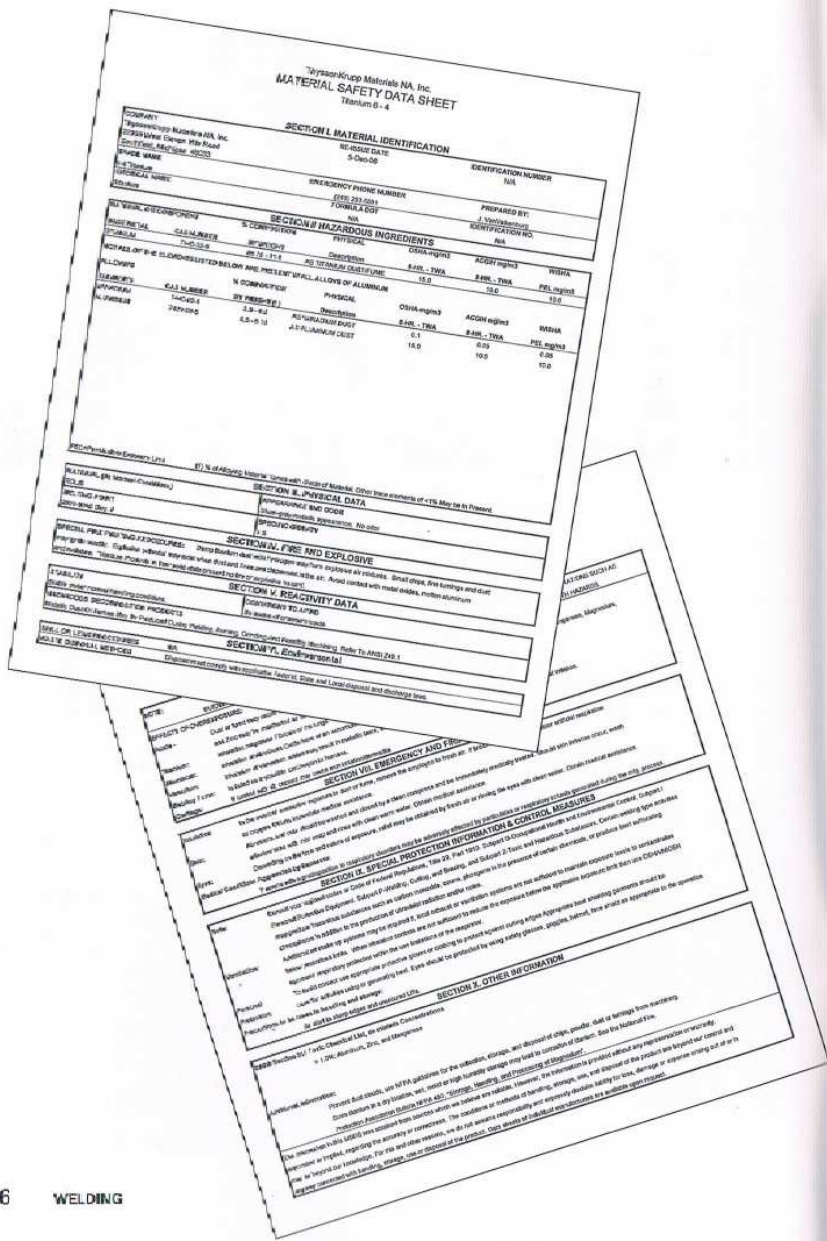

The format of the MSDS may vary, but by U.S. law, all must include certain information presented in eight specific sections. Some internationally formatted sheets will have up to 16 sections. Here are the eight required sections, although many manufacturers include additional information, such as emergency and first-aid procedures.

**Manufacturer Information.** Identifies the material and lists the manufacturer's name, address, and emergency telephone number.

**Hazardous Ingredients.** Lists the hazardous ingredients in the material and some of the exposure limits (such as the permissible exposure limit, or PEL).

**Physical and Chemical Characteristics.** Tells what the material will look and smell like, whether it is a liquid or solid, the melting point (if it is a solid), and what will cause it to react.

**Fire and Explosion Hazards.** Tells whether the material is flammable and lists the flash point, firefighting materials and methods, and any unusual burning characteristics.

**Reactivity.** Tells how other chemicals will react with the material.

**Health Hazards.** Lists known routes of entry into the human body and the health risks from each, and lists any cancer research that might have been done on the material. Describes how to recognize and treat overexposure.

**Precautions for Safe Handling and Use.** Lists procedures to use in case of accidental spills and gives information about proper disposal.

**Control Measures.** Lists ways to avoid making contact with the material, such as using respirators, wearing gloves, and working in a well-ventilated area.

Most materials necessary for welding, such as tubing, bars, and sheets of metal, are safe in their solid form. However, welding does create some waste that can be toxic and should be disposed of properly and according to the manufacturer. The industry has been going green in recent years, though, and some welders have seen the environmental and economical benefits of recycling slag from submerged arc welding. Processing recycled slag into flux can be a significant savings over purchasing new flux.

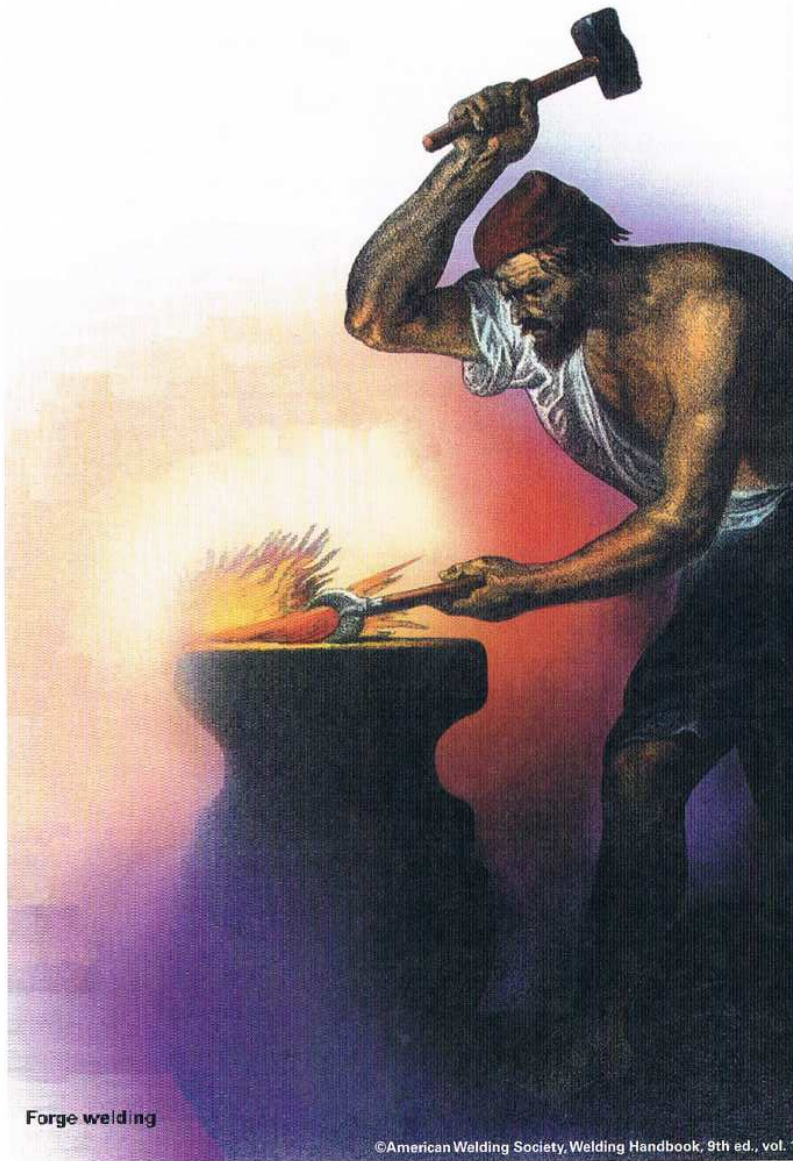

Forge welding

©American Welding Society, Welding Handbook, 9th ed., vol. 1

## Welding and Cutting Methods

Welding has come a long way since its early Bronze Age beginning. **Forge welding** is one of the oldest and simplest methods of joining metals to create one “new” piece. The forge welder heats two or more pieces of metal and hammers them together. Today, forge welding has been largely replaced by gas and electric welding, advances made during the Industrial Revolution.

This manual describes a number of conventional welding and cutting methods. Each offers an opportunity for you to learn new skills as you create, build, and alter objects or make artworks. Welding and cutting are great skills to master.



©American Welding Society, Welding Handbook, 9th ed., vol. 1

**Oxy-fuel welding** is one of the simplest methods of joining metals and has been used for more than a century.



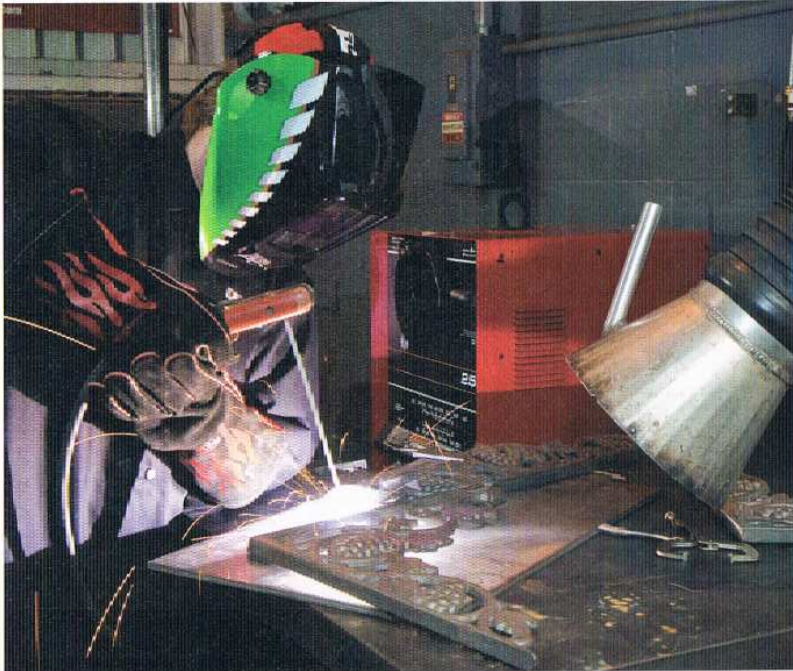

Welder using shielded metal arc welding

### Common Welding and Cutting Processes

Here are some of the more common welding and cutting processes used in a garage or shop.

#### Oxy-Fuel Welding

Oxy-fuel welding (sometimes called oxyacetylene or gas welding) and oxy-fuel cutting use fuel gases and oxygen to weld and cut metals. This process involves *oxidation*, or the combination of a substance with oxygen.

Oxy-fuel welding relies on the chemical reaction between the oxyacetylene flame and the base metal. This provides the heat to melt the base and usually a filler metal. Welders use this process to weld sheet and thin plate, tubes, and small-diameter pipes.

### ADVANTAGES AND DISADVANTAGES OF OXY-FUEL WELDING

The primary advantage of oxy-fuel welding is that it allows good control of the heat input. You can learn how to handle a torch and control your weld at a slow speed. Skilled operators with gentle movements can control the weld-bead size, shape, and weld puddle. This method is also inexpensive and portable when compared with other methods, and can even be set up in a garage shop.

Oxy-fuel welding has its disadvantages:

- It requires a high skill level to minimize **discontinuities**.
- The OAW flame is not as concentrated as an electric arc.
- It is not economical for thick section welding (more than  $\frac{1}{4}$  inch thick).
- The welding speed is slower than arc welding speed.
- Weld-metal properties are difficult to control.



Undercut at the toe of an oxy-fuel arc weld

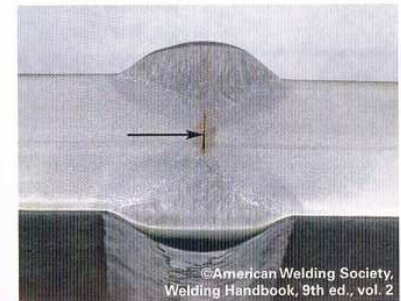

Incomplete joint penetration



Oxy-fuel welding



Porosity

Englishman Edmund Davy discovered acetylene in 1836, and the process of welding with an oxy-fuel torch (oxyacetylene torch) was developed by French chemist Henry-Louis Le Chatelier in 1895. Oxy-fuel welding was one of the first modern fusion-welding processes. It has become less popular for industrial applications but is still widely used for welding pipes and tubes, repairing objects, and fabricating certain types of metal-based artwork.

### OXY-FUEL WELDING EQUIPMENT

When welding, always wear a face shield and protective clothing.

Oxy-fuel welding requires two cylinders of gas—one for oxygen and one for fuel gas. It also requires gas-flow regulators, hoses, check valves, flashback arrestors, and a welding torch-and-tip assembly. Oxy-fuel torches may be light or heavy duty. Nozzles and tips attach to the torch head. Gas flows through the welding tip just prior to ignition and burning. Manufacturers specify tips by orifice diameter or drill size. Recommended tip sizes are based on material thickness. The fuel-gas hose is red; the oxygen hose is green. The T-grade hose is for use with all fuel gases; R-grade is for acetylene only.

For safety, the oxygen fitting has right-hand threads; when you turn the fitting to the right, it will tighten. The fuel-gas fitting has left-hand threads with grooved nuts; when you turn it to the left, it will tighten. This prevents someone from accidentally connecting the fuel-gas to the oxygen receptacle, and vice versa.

In oxy-fuel welding, a welding torch is used to fuse the base metals by heating the two pieces to a temperature that produces a shared molten pool of metal. The molten pool is generally supplied with additional filler metal.

When you are finished using the welding torch, turn off the flame, coil the hoses, and store them on the appropriate brackets on the torch cart. If there are no brackets, store the torch and hoses away from any heat sources, out of the way to prevent a tripping hazard. Turn off the gas cylinders.

Store all hand tools safely in the appropriate place in a tool box or cabinet. If there is weld spatter on the welding table, grind off the table to remove the weld spatter. With a hand broom, sweep off the welding table. With a floor broom, sweep the floor. Always leave the area neat and clean, ready for the next welder and project.

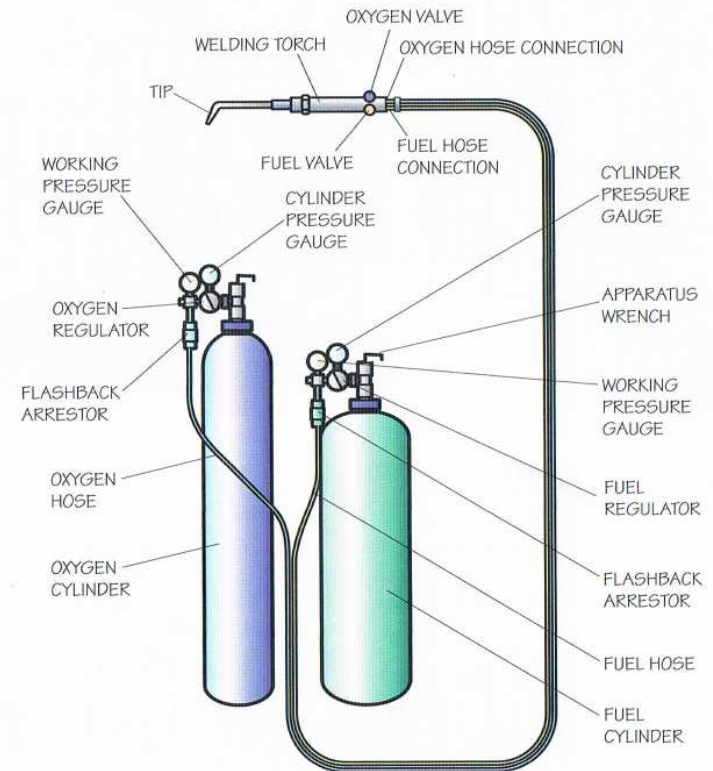

Setup for oxy-fuel welding (secure cylinders)

A valve is a device that prevents the flow of gas from a cylinder when it is not in use.

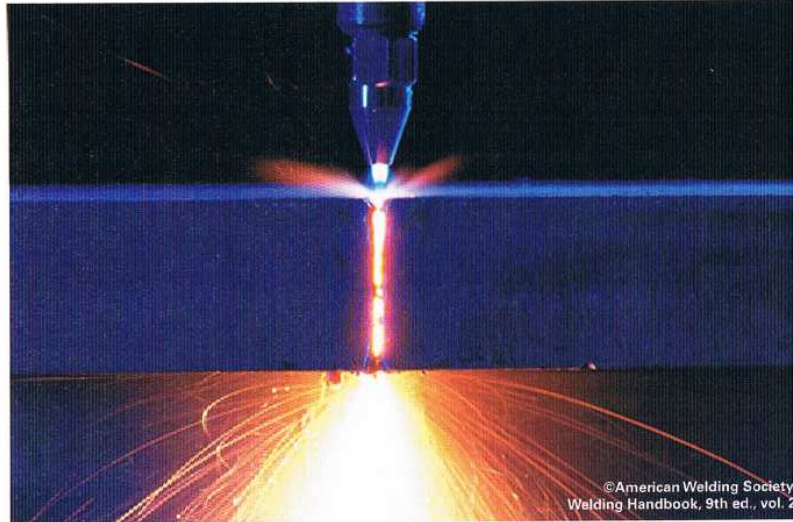

Oxy-fuel cutting

Oxy-fuel equipment lends itself to applications such as iron or steel welding, brazing, metal heating (for bending and forming), and oxy-fuel cutting.

**Oxy-Fuel Cutting**

In oxy-fuel cutting, a cutting torch is used to heat metal to kindling temperature (generally red for iron alloys). A stream of oxygen is then trained on the metal to oxidize (burn) the metal. The slag, or burned metal, is removed from the cut (*kerf*).

**Cutting to Size**

If you are working with steel plate, tubing, or iron, you may need to cut some materials to size before welding. Cuts can be made mechanically or thermally. Thermal cutting confines cuts to a narrow, well-defined zone of controlled width, or kerf. Oxy-fuel cutting and plasma arc cutting are two widely used thermal methods. Oxy-fuel cutting severs ferrous metals by oxidizing the iron in oxygen to form iron oxide slag.

The setup for manual oxy-fuel cutting is similar to oxy-fuel welding, although the torch attachment is different. The cutting torch attachment functions are designed to (1) control the flow and mixture of fuel gas and preheat the oxygen, (2) control the flow of cutting oxygen, and (3) discharge the gases through the cutting tip at the proper speed and volume for preheating and cutting.

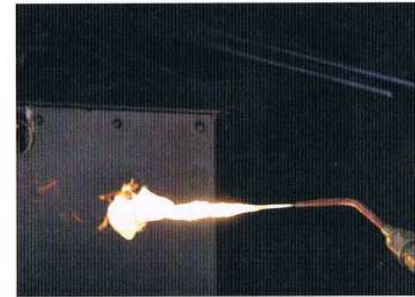

(A) PURE ACETYLENE FLAME



(B) CARBURIZING FLAME

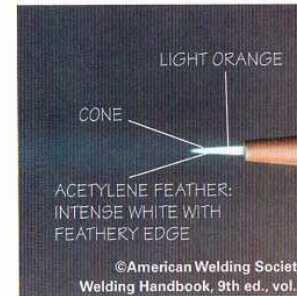

(C) NEUTRAL FLAME

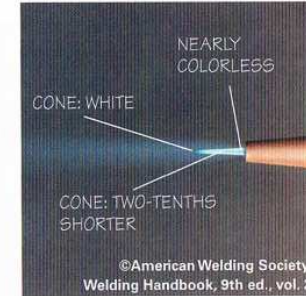

(D) OXIDIZING FLAME

**Oxy-fuel flames**

Ferrous metals contain iron. Nonferrous metals do not.

### ADVANTAGES AND DISADVANTAGES OF OXY-FUEL CUTTING

The advantages to oxy-fuel cutting are its low cost, portability, and versatility of cutting direction and size. However, the disadvantages of oxy-fuel cutting are poorer tolerances compared with machine tools, potential fire, fume and burn hazards, and the requirements of adequate ventilation.

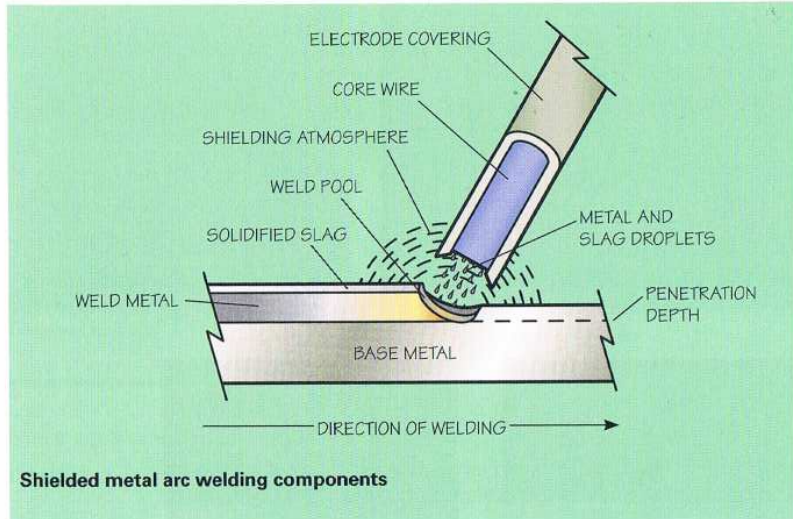

Shielded metal arc welding components

### Shielded Metal Arc Welding

In 1890, C.L. Coffin of Detroit was awarded the first U.S. patent for an arc welding process using a metal electrode. This was the first record of the metal melted from the electrode carried across the arc to deposit filler metal in the joint to make a weld. By 1900, **shielded metal arc welding (SMAW)**—the process of using a coated metal electrode—had been developed in Great Britain. A thin coating of clay or lime was applied to the bare rod by dipping short lengths into a thick paste and allowing the coating to dry. This coating provided a more stable arc with the gas and flux shielding to protect the molten weld puddle.

### ADVANTAGES AND DISADVANTAGES OF SHIELDED METAL ARC WELDING

Because of its versatility (a wide variety of metals can be used) and simplicity, shielded metal arc welding (often called “stick welding”) remains one of the world’s most popular and useful welding processes. It involves using the heat of an electric arc between a covered metal electrode and the work. SMAW equipment is also inexpensive and can be used in remote areas. Gasoline and diesel-powered generator/welding equipment make the process portable; small, lightweight inverter power sources are available. The process is less sensitive to wind and draft than gas-shielded arc processes, making it more suitable to the outdoors than other methods.

Compared with its advantages, shielded arc welding has few disadvantages. The fumes this process emits can make it undesirable to weld indoors, and the length of the electrodes can limit its productivity. If not cleaned properly, a weld can also contain slag inclusions, or pockets of material (most often slag or flux) that get trapped in and between the weld metal and the base metal, making the weld porous and weak.



Slag peeling off shielded metal arc welding workpiece



©American Welding Society, Welding Handbook, 9th ed., vol. 2

**Shielding** means protecting the weld metal from contamination. In shielded metal arc welding, as the weld is laid, the flux coating of the electrode disintegrates, giving off vapors that shield the weld area from atmospheric contamination.



Gas metal arc fillet weld

### Gas Metal Arc Welding

In 1948, using the principle of shielding the welding arc with inert gas, **gas metal arc welding (GMAW)** was developed. In this method, a continuously fed wire electrode was used to create the electric arc and as a consumable filler metal. Improvements in welding power supplies and the use of smaller-diameter wires greatly improved the process. Because of the high cost of inert gases (helium and argon), this process was first developed to join nonferrous metals. Later developments allowed the use of less expensive CO<sub>2</sub> shielding gases with steel, which led to variations of the process, including spray-arc, short-circuiting arc, and pulsed-arc transfers.

Gas metal arc welding uses the heat of an electric arc between a continuously fed bare wire filler-metal electrode and the work. Arc shielding comes from externally supplied gas.

A variation of gas metal arc welding uses a tubular electrode containing metallic powders that also requires a gas shield to protect the molten **weld pool** from atmospheric contamination. For most home and shop applications, the power source and wire feeder controller automatically control the arc length and electrode feed.

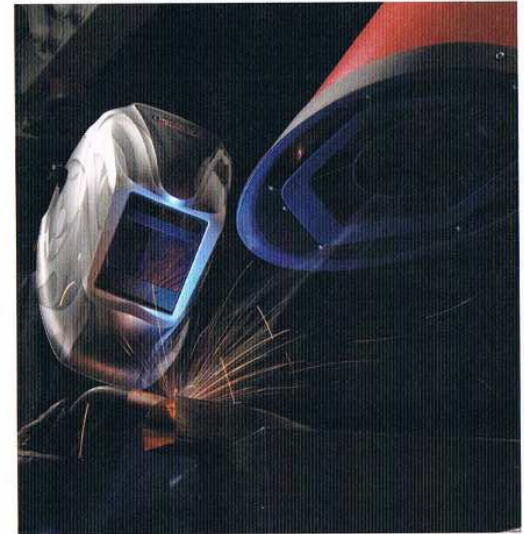

Fume exhaust

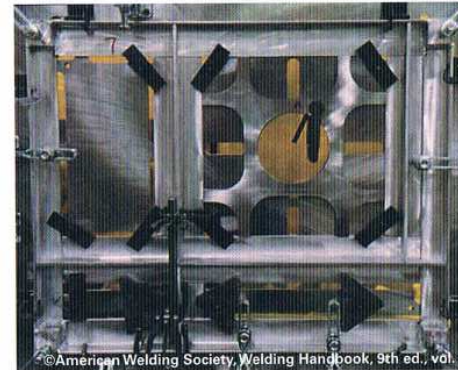

©American Welding Society, Welding Handbook, 9th ed., vol. 1

Welding fixture used to hold parts in position while welding

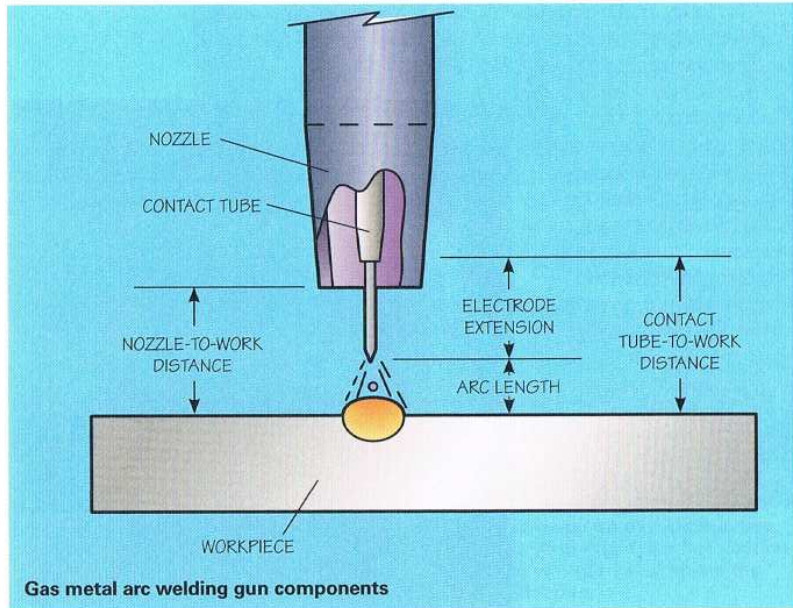

The gas metal arc process deposits the weld metal in the joint by one of three methods: **short-circuiting transfer**, **globular transfer**, or **spray transfer**. Several factors determine the type of transfer, including magnitude and type of welding current, electrode diameter, electrode composition, electrode extension, and shielding gas.

Short-circuiting transfer uses the lowest range of welding currents and electrode diameters. It produces a small, fast-freezing weld pool that is generally suited for joining thin sections, for out-of-position welding, and for bridging large root openings. In short-circuiting transfer, the wire contacts the workpiece and the arc is extinguished. Current continues to flow and the resistance causes the wire to separate and the arc to reignite, thereby causing the weld to be deposited drop by drop.

Globular transfer occurs at low currents in relation to the size of the electrode, regardless of the type of shielding gas, although CO<sub>2</sub> is commonly used to weld mild steel. Low current density at the electrode tip produces large, irregular drops

of metal that transfer to the pool without much direction, and is typically used only in the flat position. The result is increased amounts of spatter, as compared to spray transfer.

With higher welding current and voltage and a shielding gas greater than 80 percent argon, the welder can produce a stable, spatter-free weld in the axial spray transfer mode. Above the transition current level, the metal "pinches off" in fine droplets many times per second. The current propels the droplets axially down the center of the arc, away from the electrode, and straight into the pool. This mode of transfer is best suited for flat and horizontal position welding.

Shielding gases protect gas metal arc welds from the atmosphere. Fluxes are not used in this process. All deoxidizers and alloying **elements** are incorporated into the electrode wire. The shielding gas and flow rate also effect arc characteristics, modes of metal transfer, penetration and weld bead profile, speed of welding, undercutting tendency, cleaning action, and weld metal mechanical properties.

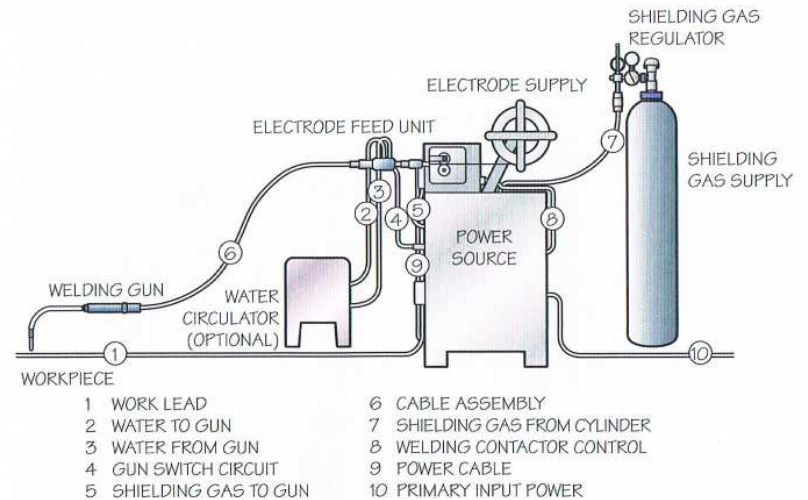

**A typical gas metal arc welding setup (secure cylinder)**

### ADVANTAGES AND DISADVANTAGES OF GAS METAL ARC WELDING

Gas metal arc welding is useful when the presence of hydrogen could cause problems. When no slag is present as with shielded metal arc welding, the welder can more easily observe the action of the arc and the weld puddle to improve control. With little or no cleaning after welding, overall operator productivity is greatly improved. Efficiency increases because the continuous spool of wire does not require changing as often as the individual electrodes used in shielded metal arc welding.

Gas metal arc welding has its disadvantages. For one, it can result in most of the common weld discontinuities except slag inclusions. Welding without adequate shielding permits atmospheric oxygen and nitrogen to dissolve in the molten metal, resulting in porosity. Higher shielding gas flow rates may also result in porosity, due to the vortex action that draws atmospheric gases into the arc region.

Drafts or wind may disperse shielding gases, making gas metal arc welding unsuitable for field welding. Incomplete fusion is possible, especially in welds made with short-circuiting transfer. The presence of undercut and underfill reflects poor welding technique. Overlap is more prevalent in globular transfer and with the short-circuiting arc. The equipment used is more complex than that used for shielded metal arc welding, increasing the possibility of mechanical problems that can affect quality.

The American Welding Society lists specifications for filler wires for various metals and related alloys. Shielding gases that protect the weld puddle from the atmosphere include carbon dioxide, argon, and helium, used individually and in mixtures that may include oxygen. Used for short-circuiting transfer to 200 amps, carbon dioxide gives a stable arc. Additions of argon smooth the arc and reduce spatter.

### EQUIPMENT FOR GAS METAL ARC WELDING

Gas metal arc welding requires a welding power supply, wire feeder, welding gun, a supply of shielding gas with flow meter and regulator, electric cables, and hoses to convey the shielding gas and cooling water. The welding gun guides filler wire and shielding gas into the weld puddle, transmitting current through

a cable from the power source. High-amperage guns come with tubing for water to cool the gun.

Stored under pressure for ready access in cylinders or in bulk containers, shielding gas travels through hoses, gun, and into the weld zone. Regulators and flow meters control gas flow. Cables are constructed of drawn copper strands. The electrode lead carries current to the gun; the work lead, grounded, completes the circuit.

Gas hoses with accessories such as connectors and clamps route the shielding gas from the cylinder or tank to the welding gun. Water for cooling high-amperage guns comes through a flexible hose. Gas metal arc welding typically uses solid wire, spooled or reeled, for continuous feeding to the gun, with diameters from 0.035 to 1/16 inch.

### Flux-Cored Arc Welding

After the introduction of CO<sub>2</sub> with gas metal arc welding, **flux-cored arc welding (FCAW)**, a variation using a special electrode wire, was developed. This wire was tubular in cross-section, with the fluxing agents on the inside. More developments eliminated the external gas, leading to the self-shielded welding wire. Flux-cored arc welding uses the heat of an arc between the electrode wire and the work.

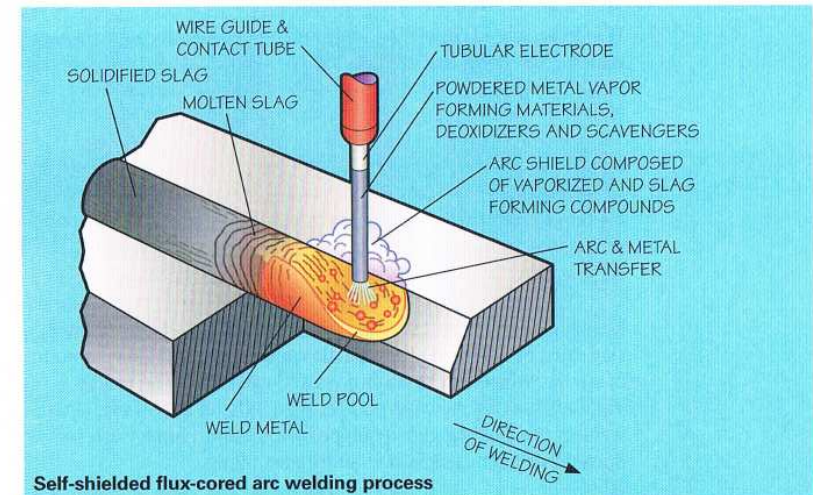

Self-shielded flux-cored arc welding process

The American Welding Society's identification system for flux-cored arc welding electrodes follows the general pattern. Shielding is obtained, in whole or part, from a flux contained within the tubular electrode. Self-shielded electrodes require no external gas protection. Non-self-shielded flux-cored electrodes use additional external gas shielding (commonly, carbon dioxide or argon/carbon dioxide mixes) supplied through the welding gun.  $\text{CO}_2$ , which is the least costly, gives globular transfer. With a mix of 75 percent argon and 25 percent  $\text{CO}_2$ , transfer approaches spray. Inert gases increase the efficiency of oxidizers in the wire core. Argon protects the molten weld pool at all weld temperatures.

Flux-cored arc welding owes its versatility to the wide variety of ingredients that can be included in the core of a tubular electrode. The tube contains granular flux, deoxidizers, and alloying elements within the tubular wire. The selection of filler alloys depends on the base metal composition, base metal cleanliness, thickness, and service.

#### ADVANTAGES AND DISADVANTAGES OF FLUX-CORED ARC WELDING

Due to increased deposition rates and a high tolerance for contamination, flux-cored arc welding has replaced shielded metal arc welding and gas metal arc welding in many applications. Flux-cored arc welding can be used in both shop and field applications and provides high productivity in terms of the amount of weld metal that can be deposited in a given time, particularly for the handheld process. This process is characterized by an aggressive, deeply penetrating arc that tends to reduce the possibility of fusion-type discontinuities. Flux-cored arc welding can be used in all positions.

As for the disadvantages of flux-cored arc welding, because a flux is present during flux-cored arc welding, a layer of solidified slag must be removed. The flux also generates a significant amount of smoke, which can be hazardous and can reduce the welder's visibility, making the weld puddle more difficult to observe. Often, welders use welding guns equipped with built-in fume extractors ducted to a filter canister and an exhaust pump.

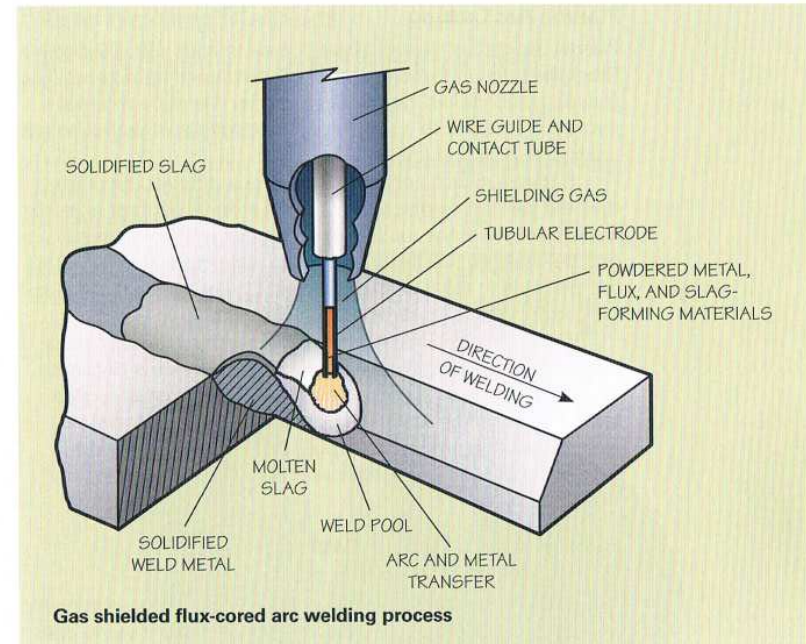

Gas shielded flux-cored arc welding process

#### Discontinuities in Flux-Cored Arc Welding

The most prevalent discontinuities in flux-cored arc welding are porosity and slag entrapment. Inadequate shielding or a disruption in the shielding gas atmosphere causes porosity. Improper travel speed or incorrect manipulation of the welding gun often results in slag entrapment.



### Plasma Arc Cutting

Plasma arc cutting uses the heat of a plasma arc (40,000 degrees Fahrenheit) to cut through any metal, ferrous or nonferrous. The plasma arc torch, which features a copper electrode recessed into a copper tip with a small opening, constricts the plasma gas in order to heat and ionize it.

A trigger switch controls most manual torches: Press to start the gas and cutting arc; release to stop. A pilot arc is established, and when the torch is close enough to the workpiece that the pilot arc touches it, an electrically conductive path from the electrode to the workpiece is created. The material melts and the cutting gas blows the molten metal away.

The plasma gas cuts a bevel on one side of the kerf and a right-angle edge on the opposite side. The gas swirls clockwise, placing the bevel on the left. This requires the worker to plan for the bevel on the scrap side of the cut. The welder can rate the cut quality according to surface smoothness, kerf width, parallelism of faces, adherence of dross to the cut bottom, and sharpness of the bottom faces.

### ADVANTAGES AND DISADVANTAGES OF PLASMA ARC CUTTING

Plasma arc cutting is faster than other types of thermal cutting for material less than 1 inch (25.4 mm) thick. Because it works with a high-velocity jet of gas, the plasma arc cuts molten material without preheating.

Its disadvantages are that plasma arc cutting is noisy, bright, and hot. All operators must wear ear protection (earplugs), a shaded face shield or helmet, and protective clothing. This method also involves hazards such as fire, electric shock, intense light, fumes, gases, and high noise levels. Another disadvantage is that the equipment costs more than oxy-fuel cutting equipment, and setups require both compressed air or gas and electrical power.

In addition to thermal methods of cutting, there are also mechanical methods such as grinding, shaping, sawing, shearing, chipping, and milling. The major concern for preparation after mechanical cutting is the thorough removal of all oils and lubricants used during cutting that will interfere with later welds.

### Other Welding Methods

A few other welding and cutting methods are discussed briefly here.

#### Submerged Arc Welding

In the 1930s, the automatic process of **submerged arc welding (SAW)** was developed and became popular in the piping and shipyard industries. In this process, the electric arc is covered by a powdered flux that protects the molten weld pool from the detrimental effects of the atmosphere. It is useful for filling joints in heavy plate and pipe.

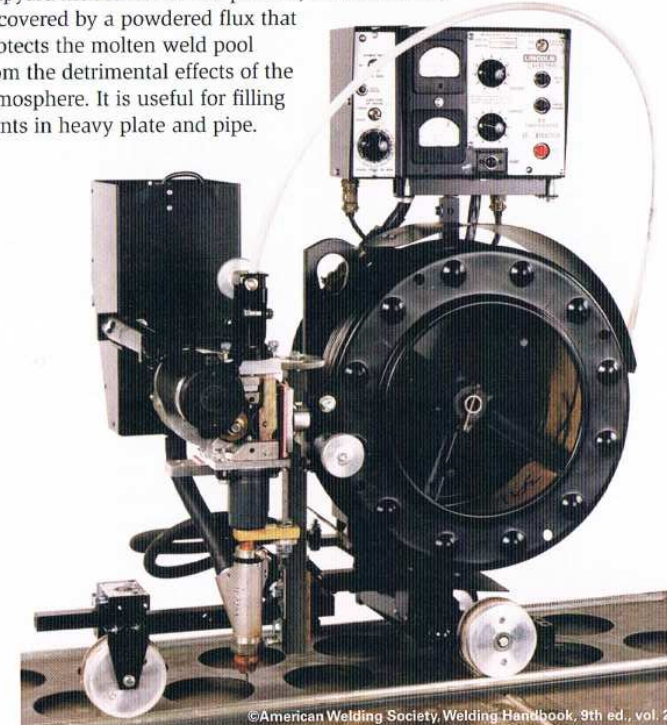

Self-propelled tractor used for submerged arc welding ships

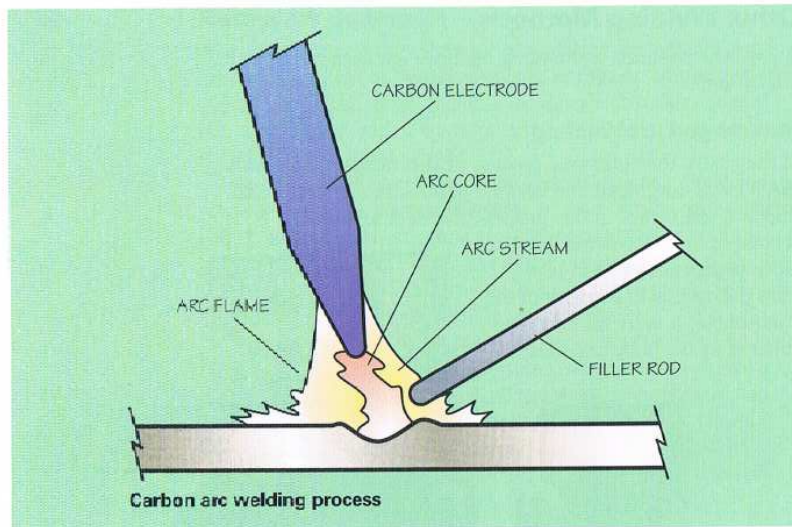

### Carbon Arc Welding

The production of an arc between two carbon electrodes using a battery was first credited to the British chemist Sir Humphry Davy in 1800. In 1885, Russian researcher Nikolai Benardo, working in a French laboratory, was granted a patent for carbon arc welding to join lead plates together for storage batteries. Efforts were also made to join iron components, and the process became popular in the late 1890s and early 1900s.

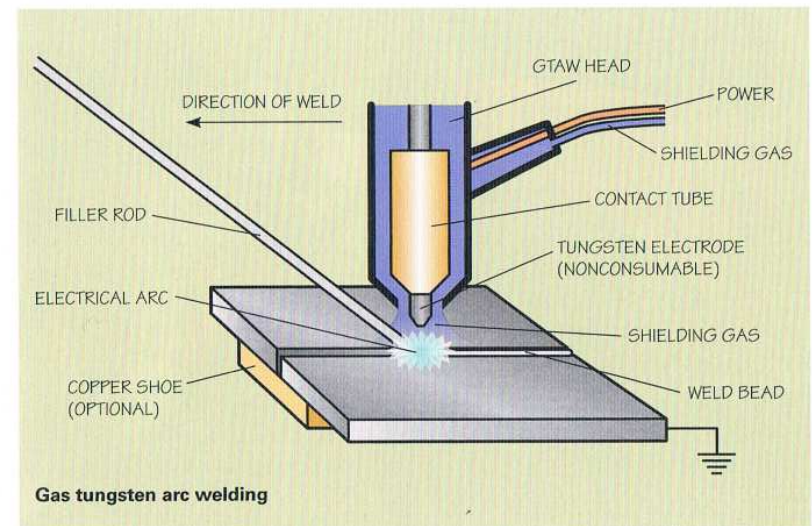

### Gas Tungsten Arc Welding

**Gas tungsten arc welding (GTAW)** uses a nonconsumable tungsten electrode to produce an arc to melt the base metal. The weld area is protected from atmospheric contamination by a shielding gas (usually argon and a filler metal).

Plasma arc welding is a variation of gas tungsten arc welding whereby the electric arc is contained inside the torch and the heat energy is transferred to the work through a plasma jet. This process can be used for metal spraying and for cutting. The plasma arc has a higher temperature than a tungsten arc.



## Preparation for Welding and Cutting

### Determining the Method

Skilled welders know the right questions to ask themselves to determine which method of welding or cutting is best suited for the particular job they are doing. They consider **weldability**, **metallurgy**, and **discontinuities**.

### Weldability

*Weldability* is the capacity of a material to be welded. The thickness of the metal often determines the best welding process to use. For heavy sections, flux-cored arc welding or shielded metal arc welding are good options. For sheet metal, oxy-fuel welding or gas metal arc welding are good choices.

### Metallurgy

Skilled welders have a knowledge of *metallurgy*, the physical and chemical behavior of metals and their mixtures (alloys).

The welding position relates to the place where the two pieces of metal meet. This is called the joint. When the joint is not in the flat position, the force of gravity limits the use of arc and gas welding.

Backside accessibility is sometimes a factor in determining the welding or cutting process to use. When the back side of a joint must be reached, the angle may be difficult to reach and weld effectively. Incomplete **fusion** or incomplete joint penetration can result.

**Discontinuities**

When welding, you may see *discontinuities* (or irregularities) that you can correct:

1. Uniformly scattered porosity usually means the welding technique was faulty or an improper filler metal was used, or the base metal was contaminated.
2. Incomplete fusion of the base metal edges can occur when the edges are inadvertently oxidized, even with the best flame adjustment; it usually is the result of improper torch manipulation.
3. Undercut, underfill, and overlap are weld faults attributable to the skill of the welder.
4. Cracks are generally hot cracks in oxy-fuel welds.
5. Throat cracks may result if the weld deposit is too thin to resist weld shrinkage stresses.

Discontinuities that result in a poor weld are porosity, incomplete fusion, incomplete joint penetration, undercut, underfill, overlap, and cracks. You can eliminate most problems by cleaning the joint and sides of the base metal, and by using proper welding technique.

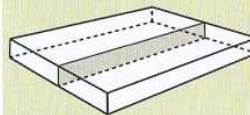
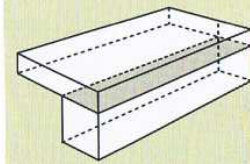
	(A) BUTT JOINT	APPLICABLE WELDS BEVEL GROOVE FLARE BEVEL GROOVE FLARE V-GROOVE J-GROOVE SQUARE GROOVE U-GROOVE V-GROOVE BRAZE
	(B) CORNER JOINT	APPLICABLE WELDS FILLET BEVEL GROOVE FLARE BEVEL GROOVE FLARE V-GROOVE J-GROOVE SQUARE GROOVE U-GROOVE V-GROOVE PLUG SLOT SPOT SEAM PROJECTION BRAZE

Weld joints

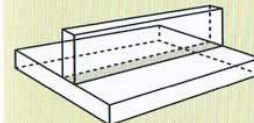
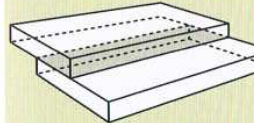
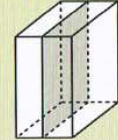
	(C) T-JOINT	APPLICABLE WELDS FILLET BEVEL GROOVE FLARE BEVEL GROOVE J-GROOVE SQUARE GROOVE PLUG SLOT SPOT SEAM PROJECTION BRAZE
	(D) LAP JOINT	APPLICABLE WELDS FILLET BEVEL GROOVE FLARE BEVEL GROOVE J-GROOVE PLUG SLOT SPOT SEAM PROJECTION BRAZE
	(E) EDGE JOINT	APPLICABLE WELDS BEVEL GROOVE FLARE BEVEL GROOVE FLARE V-GROOVE J-GROOVE SQUARE GROOVE U-GROOVE V-GROOVE EDGE SEAM SPOT PROJECTION BRAZE

Weld joints

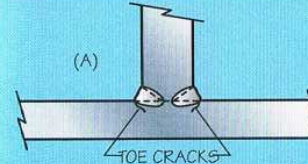
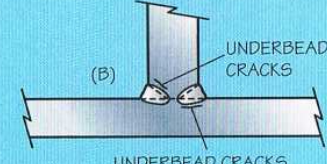
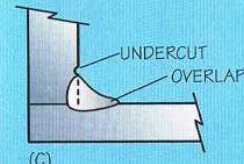
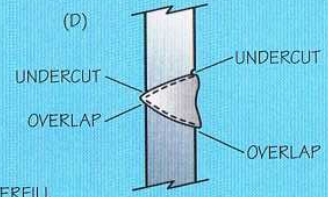
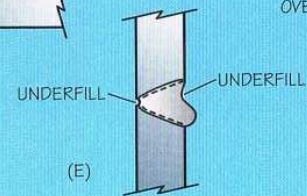
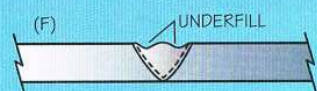
	(A)	TOE CRACKS
	(B)	UNDERBEAD CRACKS
	(C)	UNDERCUT OVERLAP
	(D)	UNDERCUT OVERLAP
	(E)	UNDERFILL
	(F)	UNDERFILL

Weld discontinuities

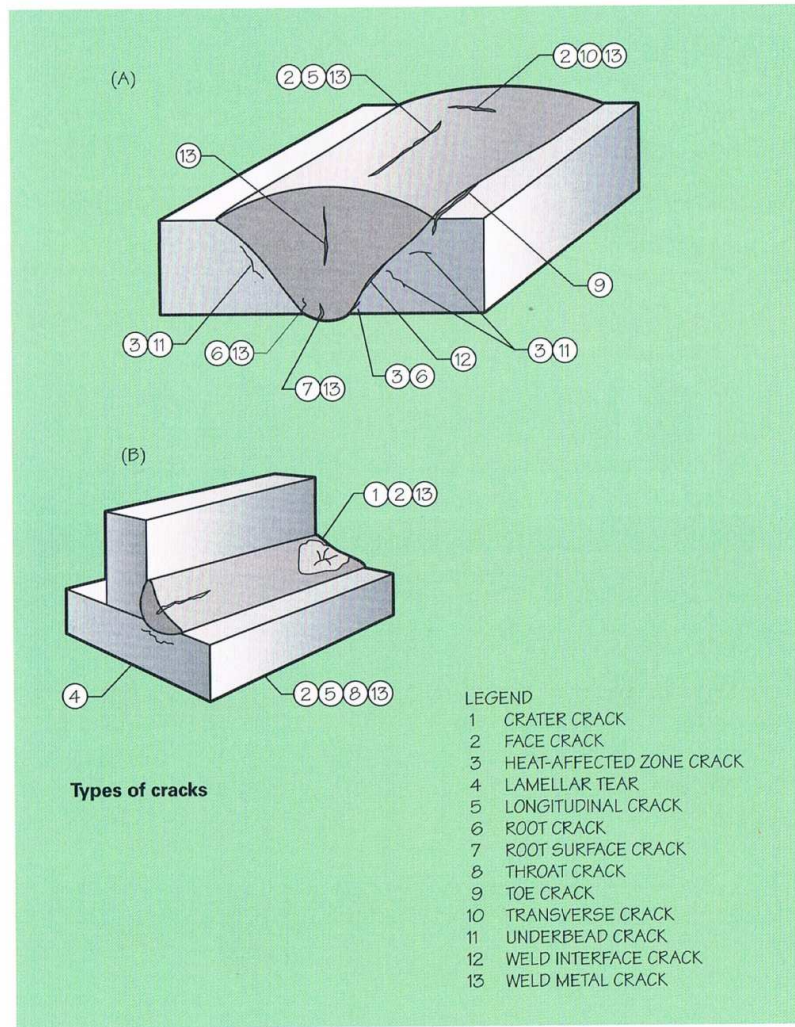

Welders can choose from a number of electrodes, metals, and alloys. A welder must stop periodically to replace electrodes and remove solidified slag. Low-hydrogen electrodes must be kept in special storage to minimize moisture absorption.

**Welding Equipment and Materials**

The equipment and materials discussed here are conventional tools of welding. For instance, common C-clamps and bar clamps hold parts to ensure precise, repeatable alignment. With portable grinders that are either electrically or pneumatically powered, you can bevel joints, grind off weld spatter, remove weld reinforcement, and help clean the scale from base material before welding. Discs and brushes offer various finishes.





Filter lenses must be worn when observing thermal cutting (oxy-fuel or plasma arc) operations. Safety goggles with side shields are required to protect eyes and face from sparks and spatter. Hearing protection (wearing earplugs) is required, as noise can exceed safe levels. Oil and grease in the presence of oxygen may spontaneously combust and burn.



Gas metal arc welding gun

©American Welding Society, Welding Handbook, 9th ed., vol. 2

Accessories for oxy-fuel include a friction lighter to ignite the gas, tip cleaners, an adjustable wrench, a cylinder truck, and safety goggles and clothing.

To prevent a flashback, which occurs when mixed gases burn behind the torch mixer, a flashback arrestor should be installed at the torch to protect the hose from burning.

Gas regulators reduce the cylinder gases from storage pressure to working pressure at the torch and maintain this lowered pressure during gas flow. Each regulator is designed to work with a specific gas. The oxygen-cylinder pressure, which can be as high as 3,000 pounds per square inch, is reduced to a working pressure of 1 to 25 pounds per square inch. The fuel gas storage pressure is reduced from 250 pounds per square inch to 1 to 12 pounds per square inch.

### Base Metal Preparation

For any welding process, the first step is to clean the base metal along the joint and sides to remove any buildup of dirt, oil, and oxides that can cause a weak weld. Grinding the surface of the base metal to a smooth, shiny finish typically removes the oxides. Carefully space the part for welding; follow all specifications. The root opening should allow for bridging the gap but should be large enough for full penetration.

Edge preparation depends on the material thickness. Sheet metal can normally be butted together and welded. For material that is  $\frac{3}{16}$  to  $\frac{1}{4}$  inch thick, a slight root opening or groove and a filler metal are necessary for complete penetration. Thicker materials should be beveled for better penetration and fusion at the sides.

Revisit the "Health and Safety" chapter whenever necessary.

Hazards of oxy-fuel welding are heat and light radiation, fumes and gases, noise, fire, and explosion. Proper use of equipment—especially of compressed-gas cylinders—is vital. The oxy-fuel flame is less intense than the electric arc but requires that shaded lenses be worn. For heat protection, wear a shaded or clear face shield. Always wear goggles to protect your eyes from sparks, spatter, and molten slag. Keep your head out of the fume plume.



©American Welding Society, Welding Handbook, 9th ed., vol. 2

Cutting steel with an oxy-fuel torch



Plasma arc cutting

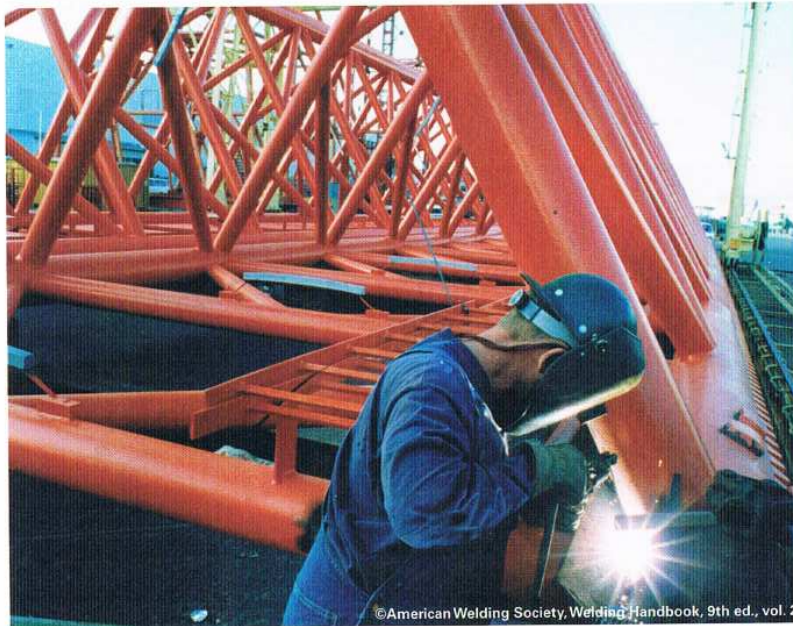

Shielded metal arc welding (or "stick welding")

Oxy-fuel operators should wear a number 4 or 5 lens when welding material is less than  $\frac{1}{8}$  inch thick, number 5 or 6 when welding material is  $\frac{1}{8}$  inch to  $\frac{1}{2}$  inch thick, and number 6 or 8 when material is thicker than  $\frac{1}{2}$  inch.



Oxy-fuel welding equipment

Be sure the grinder you use is safe by using this checklist from the Occupational Safety and Health Administration, which can also be found at [www.osha.gov/SLTC/machineguarding/new-grinder-checklist.html](http://www.osha.gov/SLTC/machineguarding/new-grinder-checklist.html). Address questions answered with a "no" before using the grinder.

### Checklist for Abrasive Wheel Equipment Grinders

- Do side guards cover the spindle, nut and flange, and 75 percent of the wheel diameter? Yes  No
- Is the work rest used and kept adjusted to within 1/8 inch (0.3175 cm) of the wheel? Yes  No
- Is the adjustable tongue guard on the top side of the grinder used and kept to within 1/4 inch (0.6350 cm) of the wheel? Yes  No
- Is the maximum RPM rating of each abrasive wheel compatible with the RPM rating of the grinder motor? Yes  No
- Before new abrasive wheels are mounted, are they visually inspected and ring-tested? Yes  No
- Is cleanliness maintained around grinders? Yes  No
- Are dust collectors and powered exhausts provided on grinders used in operations that produce large amounts of dust? Yes  No
- Are goggles or face shields always worn when grinding? Yes  No
- Are bench and pedestal grinders permanently mounted? Yes  No
- Is each electrically operated grinder effectively grounded? Yes  No
- Are fixed or permanently mounted grinders connected to their electrical supply system with metallic conduit or other permanent method? Yes  No
- Does each grinder have an individual on and off control switch? Yes  No

Fume exhaust equipment removes chemical fumes and vapors, oil mist, and dust. Equipment ranges from fans and blowers to exhaust hoods and smoke-extraction welding guns.

### Gases

Oxygen for welding and cutting should be at least 99.5 percent pure. Burning acetylene gas with pure oxygen fed through a torch produces the oxy-fuel flame. Oxygen in the air completes the combustion. For most applications, the 5,600-degrees-Fahrenheit flame provides both the heat and necessary shielding of the molten metal. Fluxes improve the cleaning action on some materials.

Oil or grease in the presence of oxygen may spontaneously combust and burn. Oxygen cylinders must be stored away from flammable and combustible material. Do not store oxygen or acetylene cylinders in confined spaces such as boxes, trunks, or vehicles. Acetylene cylinders should be kept upright. Keep equipment free of grease and oil.

### Filler Metal and Electrodes

Filler rods, used for welding of material thicker than 1/16 inch with oxy-fuel welding, are fed manually. Rods are 1/4 inch or slightly less in diameter; standard lengths are 18, 24, and 36 inches. Electrodes for shielded metal arc welding are usually 3/16 inch or less in diameter and standard lengths of 14 inches, while electrodes for gas metal arc welding and flux cored arc welding are in coils.

### Focus on the Arc

What happens in the weld puddle determines the weld quality. For arc welding processes, the heat of the arc melts the base metal and the tip of a consumable covered electrode. Understanding the electrical circuit will help you become familiar with the process. The following descriptions explain shielded metal arc welding but are similar for other common arc welding processes.

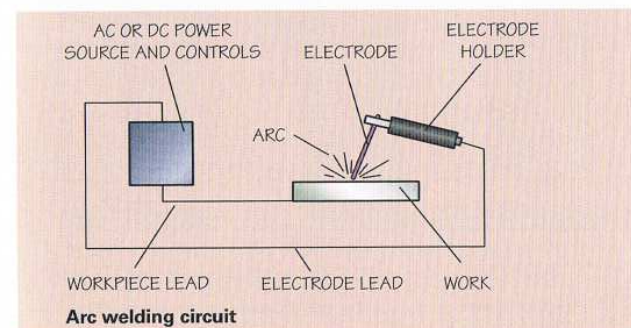



This circuit begins with the electric power source and includes the welding cables, an electrode holder, a workpiece connection, the workpiece (**weldment**), and an arc welding electrode.

One of the two cables from the power source is attached to the work. The other is attached to the electrode holder. When the arc strikes between the electrode and the workpiece, welding begins.

The heat of the arc, measured above 9,000 degrees Fahrenheit, melts the tip of the electrode and the surface of the work, near the arc. Tiny globules of molten metal rapidly form on the electrode tip, then transfer through the arc stream into the weld pool, depositing the filler metal as the electrode is consumed.

The amount of electric current needed at the arc depends on the size of the electrode and the gap between the electrode tip and the base metal. The sizes and types of electrodes for shielded metal arc welding define the arc voltage and amperage requirements. The current may be either alternating or direct (electrode positive or electrode negative), depending on the electrode being used. Manufacturers add alloying elements to the electrode covering to strengthen a shielded metal arc weld. Some ingredients and the binder in the covering can attract and hold moisture, which may cause cracking.

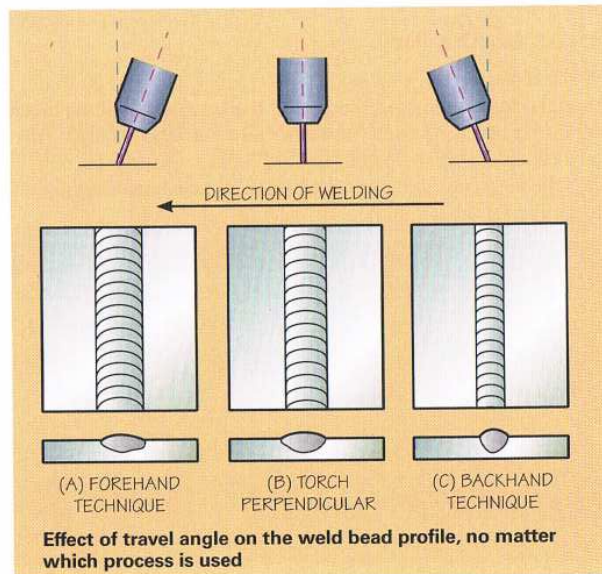

The electrode coating:

1. Provides a gas to shield the arc and prevent excessive atmospheric contamination of the molten filler metal.
2. Provides ingredients to cleanse the weld.
3. Establishes the electrical characteristics of the electrode.
4. Provides a slag blanket to protect the hot weld metal from the air and enhance the mechanical properties, bead shape, and surface cleanliness of the weld metal.
5. Provides a means of adding alloying elements to change the mechanical properties of the weld metal.

### Arc Shielding

The method of shielding and the volume of slag produced vary by type of electrode. On some electrodes, most of the covering materials are converted to gas by the heat of the arc, with only minimal slag. The gaseous shield prevents atmospheric contamination. Other electrodes convert most of the covering to slag that coats the globules of metal being transferred across the arc, then floats to the surface of the weld puddle because it is lighter than the metal. The slag solidifies after the weld metal has solidified.

The choice of electrode type depends on the application. Electrodes that produce heavy slag can carry high amperage and provide high deposition rates, ideal for heavy weldments in the flat position. Those with a light slag and lower amperage and deposition rates produce a smaller weld pool and work in all welding positions.

### How to Select an Electrode

Consider these factors in approximate order of importance:

1. Composition of the base material. For stainless steels, low-alloy steels, nickel and copper alloys, and materials that serve in corrosive atmospheres, chemical composition is important.
2. Mechanical properties of the base material. **Tensile strength** and yield strength of the weld metal should equal or exceed that of the base material.

The American Welding Society classifies welding rods and electrodes for steel on the basis of strength, position, and chemistry.

For your own comfort, choose the smallest size electrode holder that will hold your electrode without overheating.

3. **Welding position.** This is the first performance characteristic to consider. High-cellulose coating, like those on E6010 and E6011 electrodes, generate a light slag that makes for rapid solidifying of the weld metal, good for out-of-position welds.
4. **Weld current.** Covered electrodes run on alternating current, or direct current, or both. When welding DC, the positive lead typically connects to the electrode (direct current electrode positive, or reverse polarity). Some suppliers design electrodes that weld with the electrode negative (direct current electrode negative, or straight polarity). Ensure that the electrode will perform with the type of current available.
5. **Joint design and material thickness.** Some electrodes create an arc that penetrates deeply, performing well on thick sections with narrow grooves or no bevel. Poor fit-up calls for electrodes that can bridge wide gaps.
6. **Productivity.** Meeting all other conditions, select the electrode that gives the highest deposition rate.
7. **The American Welding Society electrode numbering for shielded metal arc welding electrodes is shown in AWS A5.1, Specification for Covered Carbon Steel Welding Electrodes.** "E" stands for electrode. The first two digits (or the first three digits in a five-digit number) are the tensile strength of the weld deposit times 1,000. For example, an E7014 electrode has a tensile strength of 70,000 psi (70 x 1,000). The third digit is the position in which the electrode can be used. "1" is all positions, "2" is flat and horizontal only, and "4" is a vertical down low-hydrogen electrode. The last digit is the composition of the flux coating.

### Power Sources

A combination AC/DC power source is common at home. Power sources use static converters (transformers), rotating converters (generators/alternators), or inverters to produce the electrical power needed for shielded metal arc welding. These produce 25 to 400 amps at 15 to 35 volts. Either AC or DC may be used, depending on the current supplied by the power source and the electrode selected. The type of current used influences the performance of the electrode. Following are some factors to consider:

- **Voltage drop** in welding cables is lower with AC, thus improving welding at a distance from the power supply.

- Low current requirements of small-diameter electrodes and low welding currents make DC a good choice for a more stable arc and better operating characteristics.
- Arc starting is generally easier with DC, particularly if small-diameter electrodes are used. With AC, the welding current passes through zero each half-cycle; this can present problems for arc starting and arc stability unless special electrodes are used.
- Arc length is better controlled with DC when welding with a short arc length (low arc voltage) than with AC.
- Arc blow is seldom a problem with AC because the magnetic field is constantly reversing (120 times per second). Welding position in the vertical and overhead is somewhat better with DC because lower amperage can be used. With suitable electrodes, however, satisfactory welds can be made in all positions with AC.

### Accessory Equipment

An electrode holder is a clamping device with an insulated handle that allows the welder to hold the electrode. The electrode holder conducts the welding current from the welding cable to the electrode through the jaws of the holder. The jaws must be kept clean and in good condition to prevent overheating and causing an excessive voltage drop in the welding circuit.

The workpiece connection is a device that connects the workpiece lead to the workpiece. It should produce a strong connection, yet allow for quick and easy attachment. For light duty, a spring-loaded clamp may work. For high current, a screw clamp can provide a good connection.

Welding cables connect the electrode holder and workpiece clamp to the power source as part of the welding circuit. The cable size depends on the maximum amperage to be used for welding, the length of the welding circuit (welding and work cables combined), and the duty cycle of the welding machine. Miscellaneous hand tools include a steel wire brush, hammer, chisel, and chipping hammer to clean dirt, slag, and foreign matter from the welding area.



## Welding for the Novice

After you have set up an area for the welding process you have chosen, your merit badge counselor will inspect and approve the area. Before you begin, you must be trained in the proper use of regulators, if they are required, and be supervised by your merit badge counselor. Always follow the manufacturer's recommended procedures.

This section will outline the steps for only two of the most common welding processes, oxy-fuel welding and shielded metal arc welding.

### Preparing to Weld With Oxy-Fuel Welding

Cylinders should be secured to a wall or post for stability. Select the correct regulator, hose, torch, and nozzle; check to ensure that the fittings are tight and grease-free. The regulator should be clean and in good working condition at all times. When opening the cylinder valve, always stand with the cylinder valve between you and the regulator. Turn the oxygen cylinder valve slowly to full open in order to gradually increase the pressure in the regulator. Turn the oxygen regulator adjusting screw clockwise to working pressure. Close the torch-oxygen valve; then open the acetylene cylinder valve a quarter to one and a half turns.

Turn the adjusting screw on the acetylene regulator clockwise to the recommended pressure, no more than 15 *psi*, or pounds per square inch. Close the fuel gas torch valve. As the welder, you must regulate the torch flame to burn under neutral condition. With the primary reaction exactly balanced, yielding only carbon monoxide and hydrogen, the flame atmosphere is then neither carburizing nor oxidizing. This flame adjustment must be determined from the appearance of the inner flame cone. The hot metal is then protected from the atmosphere by the combustion products in the neutral flame and the fluxes, if used.

There are three types of usable flames: carburizing, oxidizing, and neutral (see page 35). A carburizing flame has an excess fuel gas in the flame, while an oxidizing flame has excess oxygen. A neutral flame has no excess of either gas and thus is the best flame for welding steel. Using a carburizing or oxidizing flame can degrade the material properties.

### Torch and Tip Technique

Before you try it yourself, your merit badge counselor can demonstrate how to hold the torch for the proper work and travel angles to weld a bead.

Practice before attempting to weld a bead into the shape of your initial.



Welding beads with shielded metal arc welding

### How to Weld a Bead

To begin welding, rotate the torch flame in a small circle at the starting edge to establish a puddle; then push the puddle along the joint. Continue this action, oscillating the torch tip across the joint in a circular or semicircular motion. Forehand and backhand welding indicate the direction of the tip relative to the completed weld.

### APPLYING WELD BEADS

Once you get the hang of it, you can take your skills to the next level and cover a plate with weld beads side by side. It will take a steady hand, but with some guidance you will have fun with this welding technique. Be sure to follow your counselor's instructions.

When you are ready to close down the equipment, turn off the torch-oxygen valve; then, turn off the fuel valve. Close the cylinder valves, then open the torch oxygen valve to allow the oxygen to drain, and close the torch oxygen valve. Release the adjusting screw on the oxygen regulator. Open the torch-fuel valve to drain fuel gas, and then close it. Release the adjusting screw on the fuel-gas regulator. Always follow the manufacturer's recommendations for startup and shutdown of the equipment you are using.

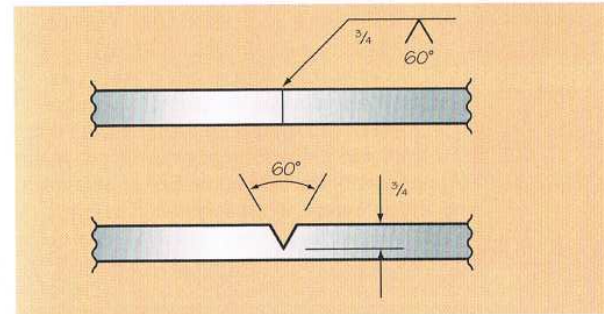

V-groove weld

### How to Weld Two Plates Together

After practicing lighting the torch and running beads on a flat steel plate, you will now learn how to weld two pieces of metal. Common joints are butt joints, T-joints, and lap joints. Welded joints are designed primarily on the basis of the strength and safety required of the weldment.

Thicker members normally require some edge preparation to allow puddle to reach the point where the weld metal must be deposited. Often on thick members, the bevel is on both sides or weld backing is used to prevent the molten metal from seeping through the root of the joint.

Although the steps here are for oxy-fuel welding, the same steps can be followed for most welding processes in which your counselor has experience and for the equipment available.

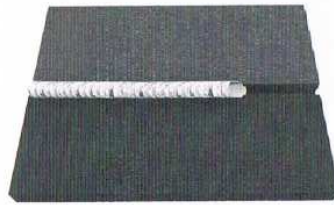

A *weave bead* means to move the weld puddle from side to side, or to weave it the width of about two or three times the electrode diameter. A *tack* or *tack weld* is a small weld bead, usually  $\frac{1}{4}$  to  $\frac{1}{2}$  inch long, used to hold the two pieces of steel together while you complete the weld. If the two pieces of steel have not been tacked together, the heat distortion will cause them to move apart or cause what is called angular distortion once you start to weld.

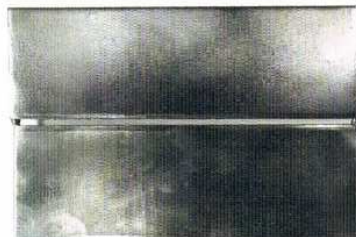

Tack welds at bottom ends of plate

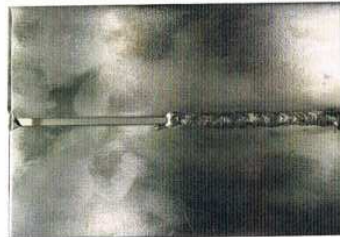

Tack holds weld in place as weld progresses

Start with a butt joint. With a weld bead, you can fill the space between the two pieces to create a single piece of metal. The two pieces can have a closed root with a square groove, or an open root with a square groove. For greater strength, you can bevel a groove angle with either a closed root or an open root with a root face.

In working with a deep groove, you may need multiple beads to fill the space. Between each pass, clean all slag from the bead surface. To fill a groove, you can make stringer beads (run beads side by side) or create a series of *weave beads*.

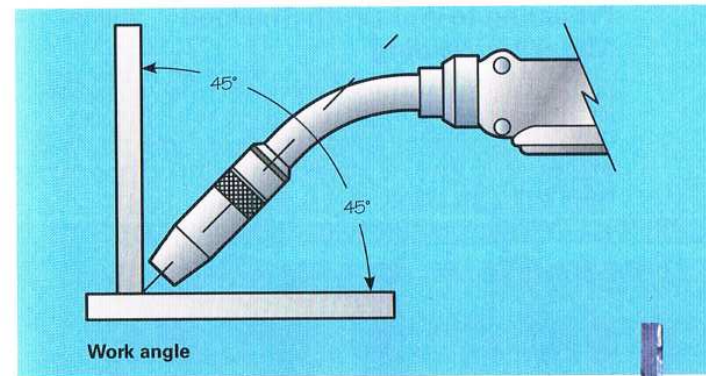

Work angle

Normally, in addition to clamps, a butt weld will require a tack weld to hold the pieces in place during the heating from the weld bead. Place the tack welds on each end of the joint. Depending on the shape of the workpiece, you may need to tack welds in other places, too, to control warping.

T-joints and lap joints can be joined with fillet welds at the intersection of the two workpieces. If the pieces are square, no end preparation is necessary. When possible, use double-fillet welds (as shown here) on both sides of the joint, between the two pieces.

A fillet weld requires holding the torch at a 45-degree work angle and the same 10-degree to 30-degree travel angle as in the flat position. Tack weld the end and other points as needed, as with a butt weld. Practice welding the flat and vertical up and down positions to learn how the heat helps or hinders your efforts.

A *fillet weld* is a right triangular-shaped weld formed at the interface between the vertical and horizontal members of a T-joint. A *double fillet weld* is a T-joint with a fillet weld on both sides of the vertical member of the joint.

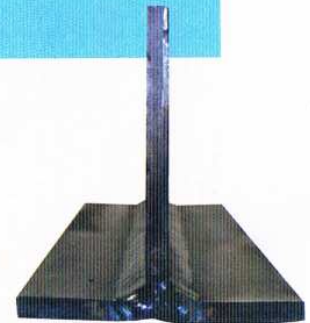

## Preparing to Weld With Shielded Metal Arc Welding

As a welder, you can control four shielded metal arc welding parameters: current setting (amperes), arc length (voltage), electrode angles (degrees), and travel speed (inches per minute). You can see the results of your skills as you weld. Compare your beads to the ones shown.

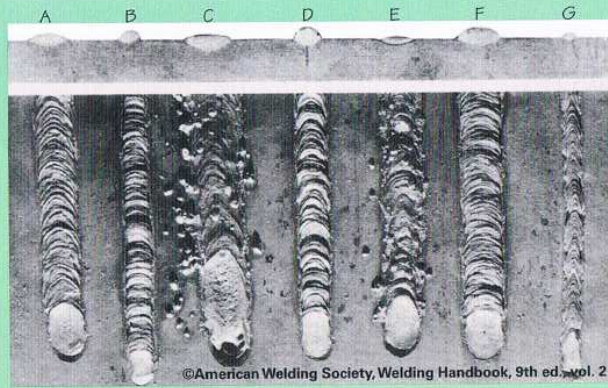

- ©American Welding Society, Welding Handbook, 9th ed., vol. 2
- (A) PROPER AMPERAGE, ARC LENGTH, AND TRAVEL SPEED
  - (B) AMPERAGE TOO LOW
  - (C) AMPERAGE TOO HIGH
  - (D) ARC LENGTH TOO SHORT
  - (E) ARC LENGTH TOO LONG
  - (F) TRAVEL SPEED TOO LOW
  - (G) TRAVEL SPEED TOO FAST

Effects of parameters on shielded metal arc welds

### Electrical Current Setting

To test the effects of current settings, use a 1/8-inch diameter E6013 electrode at varying welding currents, beginning at 115 to 125 amps, then dropping down by 5 to 10 amps. Run beads at each setting. As the amps are lowered, check the change in the weld bead until the heat is insufficient to melt the base metal. Then, start over with the 115- to 125-amp setting and increase by 5 to 10 amps. With too much heat, the electrode covering will turn black, the bead will be flat with a lot of spatter, and the base metal will become hot. With practice, and by using the manufacturer's amp setting recommendations, you will soon learn what your current settings should be.

### Arc Length

After striking the arc, the electrode is consumed, so the welder must constantly correct the arc length—the distance between the workpiece and the end of the electrode core wire. The length is approximately the diameter of the core wire of the electrode. A short arc will not generate enough heat to fully melt the base metal or the electrode. This can result in the electrode sticking to the base metal, shallow penetration, or an uneven bead with irregular shape and slag trapped in the weld.

### Electrode Angles

Shielded metal arc welding requires skill in holding the electrode in two related angles—travel angle and work angle. The travel angle, movement away from the weld bead, refers to the direction of travel the welder holds the electrode during welding. When welding on a flat plate, start with 15 to 25 degrees from vertical, tilted in the direction of travel. The work angle is 0 degrees from the vertical, or 90 degrees off the base metal.

### Travel Speed

As you move the electrode along the joint, you can determine the best travel speed for building the width and height of the weld bead. The correct travel speed should create a weld bead about twice as wide as the outer diameter of the electrode, with half-moon or crescent-shaped ripples, similar to laying down a stack of dimes.

### Prepare and Practice

Use SMAW to practice striking arcs and running beads. Then, learn to join two pieces of metal as butt joints, T-joints, and lap joints. **Follow the steps used with oxy-fuel welding.** Hold the correct electrode angle as you would when running the beads on plate.

### Discontinuities

If the SMAW process is not applied properly, the welder can produce almost any discontinuity. Improper manipulation of the electrode can cause mistakes like incomplete fusion, incomplete joint penetration, undercut, overlap, incorrect weld size, and improper weld profile.

Slow travel speed produces a bead with too much height and width and poor fusion to the base metal. High travel speed results in a low, narrow bead, a V-shaped ripple, and possible undercut along the edges.

Slag inclusions are most often the result of improper welding technique, insufficient cleaning, or insufficient access for welding within the joint.

Porosity normally results when moisture or contamination is present in the electrode coating on the surface of the material or in the atmosphere. Faulty technique can also cause porosity. Cluster porosity occurs due to long arcing at the start and stop of the arc. Porosity can result from the presence of arc blow, the deflection of an arc from its normal path because of magnetic forces. As you develop your welding technique with your merit badge counselor, you will learn to minimize arc blow.

### Variables for Arc Welding Processes

The welder has control over a number of variables that affect weld penetration, bead geometry, and overall weld quality. The variables include:

1. Welding current (electrode feed speed)
2. Polarity
3. Arc voltage (arc length)
4. Travel speed
5. Electrode extension
6. Electrode orientation (trail or lead angle)
7. Weld joint position
8. Electrode diameter
9. Shielding gas composition and flow rate

To consistently produce a satisfactory weld, you will need to learn how to control these variables. Generally, changing one variable requires changing one or more of the other variables for a good weld. Experience builds the skill to recognize how the type of base metal, electrode composition, welding position, and quality requirements affect optimum results. Your merit badge counselor can help you build these welding skills. Practice running beads on flat plate; then, work on the basic joint to gain confidence and skill.

Take responsibility and precautions for minimizing risk and avoiding injury by following the information in the "Health and Safety" chapter.

### Safety First

Review safety practices before welding. Being prepared will minimize accidents. Eye damage and skin burn are the most common injuries resulting from gas metal arc welding. Hazards include fumes, gaseous emissions, and electrical shock.

### Build a Patrol Popcorn Popper

Now that you have some welding knowledge, you can build this patrol popcorn popper with your fellow patrol members. With your merit badge counselor's close supervision, this makes an ideal group project.

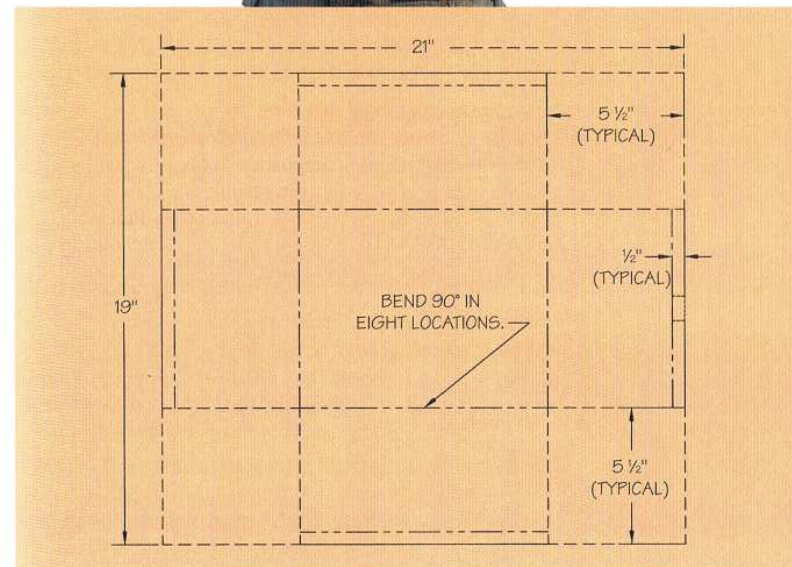
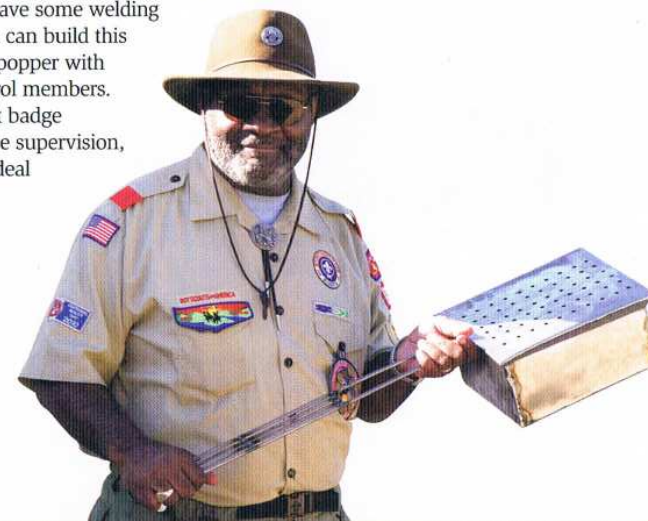



### Tools Needed

- Metal cutting shears
  - Plasma cutting torch (optional, for use in place of metal cutting shears)
  - Builder's square
  - Tape measure
  - Paint pen
  - Vise
- Sturdy table with square edge
  - Scrap piece of plywood, at least 11" x 13"
  - Hammer
  - Hacksaw
  - Pliers
  - Small pry bar or screwdriver
  - Punch
  - 2 C-clamps
  - Drill with 1/4" bit and 3/8" bit
  - Angle grinder, 4 1/2"
  - Grinding disk and sanding disk

### Materials Needed

- 22-gauge sheet, cut to 21" x 19"
- 22-gauge sheet, cut to 12 1/4" x 10 5/8"
- Round bar, 2 pieces, each 10" x 1/4"
- Round bar, 1 piece, 8 1/2" x 1/4"
- Round bar, 2 pieces, each 6" x 1/4"
- Round bar, 1 piece, 56" x 1/4"
- Wooden knob

### Required Skills

The following skills are needed for this welding project: layout, cutting, fitting, welding, grinding, drilling.

### Let the Building Begin

This project can be built from mild steel or aluminum sheet, depending on the welding process available. If it is built from aluminum, you might need more insulation for the handle to protect the cook's hands.

If you need to alter the design, be sure to write down your changes and make a new sketch on another piece of paper. Include dimensions, material callouts, and welding symbols. Have your counselor review your altered design to check for constructability and strength.

**Step 1**—Place your 21" x 19" sheet metal on a flat surface, and from all four corners, measure and mark 5 1/2" vertically and 5 1/2" horizontally. Then, using the builder's square, draw straight lines from your marks to create a 5 1/2" square in each corner.

**Step 2**—Measure and mark the 1" x 1/2" handle notch found at one end.

**Step 3**—Using shears (or the plasma cutting torch), cut out the squares in each corner.

**Step 4**—Cut the two 1/2" lines for the handle notch. (This tab will be folded back.)

**Step 5**—Next, measure and mark the fold lines, 1/2" from the edge of the remaining outside lines. The lines remaining in the center are also fold lines.

**Step 6**—Line up the fold lines at the top edges with a sharp metal table edge, and clamp securely. Tap with a hammer to get the folds started; bend to 90 degrees.

**Step 7**—Line up the inside fold lines in the same way, securely clamping, then tapping with a hammer on a sharp metal table edge.

**Step 8**—Get all four folds started. Finish bending by hand. Tack the full length of the inside edges, tapping the outside edges with a hammer as needed, to bring them together tightly.







**Step 9**—Place a  $\frac{1}{2}$ " long fillet weld in each corner to keep the popcorn oil from leaking. Full-length welds are not necessary. You can clamp thicker metal to the outside to absorb excess heat if you have trouble with burn-through.

**Step 10**—To start the handle, use the hacksaw to cut the  $\frac{1}{4}$ " round stock into pieces of the following sizes:

- One 56" piece
- Two 10" pieces
- One 8  $\frac{1}{2}$ " piece
- Two 6" pieces



**Step 11**—Find the center of the 56" piece and mark it. Place it in a vise with the mark at the edge of the vise. Bend it in half, by hand, until it has a slightly rounded middle. Place the two 6" pieces in between the bent rod and adjust them until they fit securely together. Clamp and weld.



**Step 12**—For the end of the handle, measure and mark each piece of the handle at 4 inches. Place the pieces of the handle in the vise, lining up the marks with the edge of the vise. Bend each end outward.

**Step 13**—Turn the box upside down on the table and place the remaining pieces of round stock on each of the three sides of the box. The handle becomes the fourth side of the box. Weld securely. Smooth the rough corners by grinding.



**Step 14**—Build the lid from the  $12\frac{1}{4}$ " x  $10\frac{3}{8}$ " sheet. Measure  $\frac{3}{4}$ " vertically and horizontally on both sides of each of the four corners, and draw lines to create four squares. Measure and mark  $1\frac{1}{2}$ " on both sides of each corner, and draw a straight line between the two. Cut off the corners. Measure and mark the steam holes. In the diagram, 1" blocks are used, but you may use any hole pattern you want. Place the lid on a piece of plywood and use a punch and hammer to mark the holes.

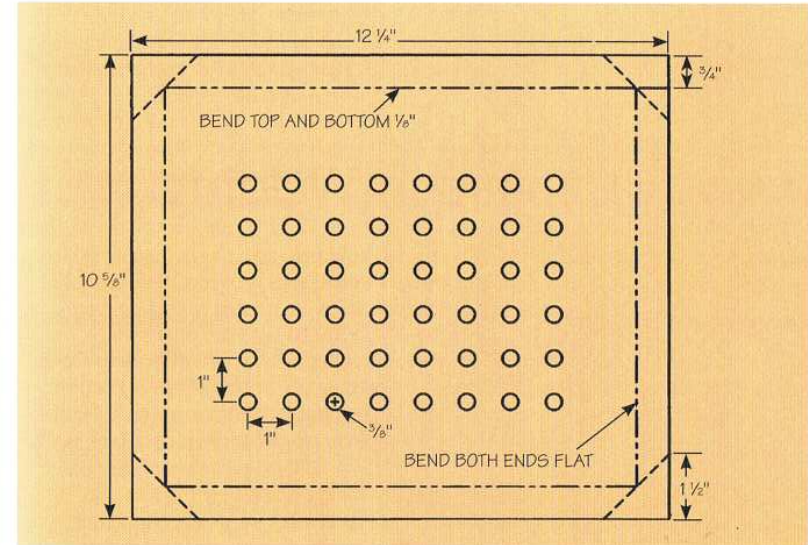

**Step 15**—Clamp the lid to the table, lining up the  $\frac{3}{4}$ " fold lines with the edge. Tap the edge with a hammer to get the fold started. Do this on all four sides. Completely bend the two shorter sides until they are flat.

**Step 16**—Bend the two longer sides to 90 degrees. Place the lid upside down on the table and place the box upside down on the lid. Use the hammer to tap the 90-degree lid folds around the round stock on the box. Turn it over, drill the punch marks, first with the smaller drill bit, then with the  $\frac{3}{8}$ " drill bit. To prevent injury from the rough sides, use an angle grinder with a flap, or a sanding disk, to smooth both sides of the drilled holes. Use a screwdriver to adjust the folds on the lid so it slides easily. Attach a wooden knob to the lid, and you are finished!



## Careers in Welding

Manufacturing businesses are experiencing a shortage of skilled welders. As baby boomers (those born between 1946 and 1964) continue to retire, skilled welders are needed to replace them. Despite the lure of \$40,000 to \$70,000 salaries after college graduation and on-the-job training, it has been difficult to recruit newcomers. This may be because the dreary image of the past century's industrial age lingers. But that era has passed. Thanks to advances in science and technology, welding has a new spark.



Welding can also be applied in the arts. Sculptor Jean Woodham created this 28-foot-high sculpture, which required a crane, cherry picker, and flatbed truck for installation.

Skilled and talented welders have a brand new place in our contemporary world. Numerous welding careers offer flexible and appealing lifestyles. Skilled welders can advance to robotic welding technicians, inspectors, supervisors, salespersons, professors, and business owners. The best place to start is right here. The American Welding Society provides information about exciting careers in the welding industry.

The American Welding Society Foundation awards scholarships to students seeking two-year technical degrees, four-year degrees, and postgraduate education. Welding education programs are modernizing and expanding. The Southeastern Institute of Manufacturing and Technology in Florence, South Carolina, with the support of the Lincoln Electric Company and ESAB Welding and Cutting, has invested heavily in new welding and cutting equipment.

A large part of the U.S. economy is dependent on welding; continued advances will help drive our nation's productivity. Whether you enjoy working with your hands, traveling the world, inspecting and analyzing, crunching numbers, communicating, or inspiring others, a career in welding may await you.

- If you enjoy building things, try welding skyscrapers in the construction industry.
- Swimmers and divers should consider underwater welding.
- Car and aeronautics enthusiasts should try the automotive or aerospace industry.
- If you are a math and science whiz, think about welding engineering and technology.
- If traveling is in your blood, welding inspection can take you to faraway places.
- For those who enjoy working with others, welding equipment manufacturers need sales and service representatives.
- Artists can try their hand at metal sculpting and ironworks.
- Aspiring entrepreneurs and business owners can open a welding repair shop.

For more information, contact the American Welding Society (see the resources section) for a copy of *Your Career in Welding: A Guide for Students, Parents, Teachers, and Career-Changeers*.

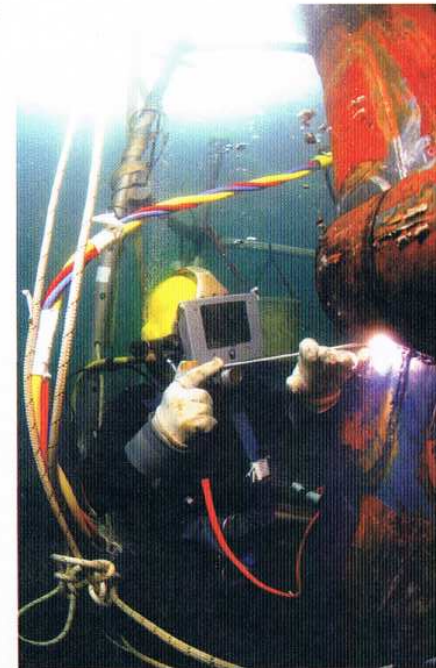

## Glossary

**alloy.** The mixing together or dissolving of one or more elements in a metallic matrix. These solutions can create complex microstructures (*see microstructure*) that can be modified with the application of heat (*see heat treatment*) or plastic deformation (cold working). Alloys usually have different properties from those of the component elements.

**American Welding Society.** A nonprofit organization dedicated to the advancement of welding and allied processes.

**amperage.** A unit of measurement that indicates the amount of current flowing in a circuit.

**arc.** The area in which electricity jumps from the electrode to the workpiece. The heat generated by the arc melts the base metals.

**arc welding.** A fusion welding process that uses electricity to generate heat to melt the base metals.

**auto-darkening welding shield.** A welding shield that automatically darkens to the predetermined welding shade when the arc is established.

**base metal.** The workpiece and the materials to be joined.

**combustible material.** An object that can quickly catch fire if it comes in contact with sparks or fire. Combustibles must never be present in a weld area.

**discontinuities.** Interruptions of the typical structure of a material, such as a lack of homogeneity in its mechanical, metallurgical, or physical characteristics.

**electric current.** The flow of electrons resulting from an electric charge. This flow, when meeting resistance either through metal or across an arc, generates large quantities of heat.

**electrical shock.** The flow of electricity through the human body that can be fatal.

**electrode.** A device that conducts electricity. In welding, it is used to conduct electrical current through a workpiece to fuse two pieces together. Depending upon the process, the electrode is either consumable, in the case of gas metal arc welding or shielded metal arc welding, or nonconsumable, as in gas tungsten arc welding. Electrodes can emit harmful fumes.

**electrode holder.** The insulated handle that clamps onto the electrode. The electrode holder must be dry and in good condition.



**element.** A pure substance that cannot be refined or purified further without the loss of its unique properties.

**exhaust.** Any of various devices used to suck harmful fumes.

**face shield.** A hand-held welding shield used for the protection of bystanders.

**filler metal.** A metal that is added in the making of a joint through welding, brazing, or soldering.

**filter plate.** The shaded protective lens inside the welder's helmet that filters out harmful rays and intensely bright light.

**fire shield.** A large, flame-resistant screen placed around the welding area to protect bystanders from spatter or from the arc's harmful rays and bright light.

**fire watcher.** A person who keeps watch over the welding area for the welder. The fire watcher must be able to respond quickly in the event of a fire or other emergency.

**flammable material.** An object that can quickly catch fire if it comes in contact with sparks or fire. Flammables must never be present in a weld area.

**flux.** A chemical cleaning agent that facilitates soldering, brazing, and welding by removing oxidation from the metals to be joined.

**flux-cored arc welding (FCAW).** A semiautomatic or automatic arc welding process using a continuously fed consumable tubular electrode containing a flux. An externally supplied shielding gas is sometimes used, but often the flux itself is relied upon to generate the necessary protection from the atmosphere.

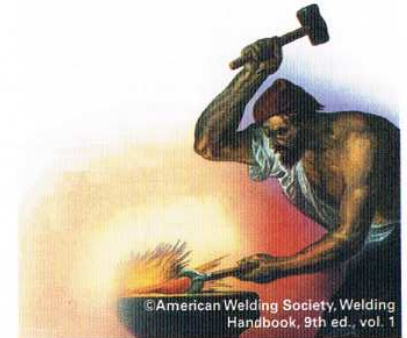

© American Welding Society, Welding Handbook, 9th ed., vol. 1

**forge welding.** A welding process in which two or more pieces of metal are heated, then hammered together. Used since ancient times, it is one of the simplest methods of joining metals.

**fume.** Metallic vapor emitted during welding, solidified into tiny particles in a weld area.

**fume plume.** A cloudlike area where welding fume collects.

**fusion.** A process of heating metal that results in the phase change of a substance from solid to liquid. The liquid metals flow together and, when cooled, form a single, uninterrupted connection.

**gas metal arc welding (GMAW).** Also known as metal inert gas welding, or MIG. A semiautomatic or automatic arc welding process in which a continuous and consumable wire electrode and shielding gas are fed through a welding gun. There are four primary methods of metal transfer in GMAW: globular, short-circuiting, spray, and pulsed-spray (*see pulsed-spray*). Each has distinct properties and corresponding advantages and limitations.

**gas tungsten arc welding (GTAW).**

Also known as tungsten inert gas, or TIG. An arc welding process that uses a nonconsumable tungsten electrode to produce an arc to melt the base metal.

**globular transfer.** A method of transferring the filler metal, typically from a wire welding process, across the arc in molten droplets larger than the diameter of the wire.

**heat treatment.** A process of changing the mechanical and physical properties of metal by applying cycles of heating and cooling controlled by specific intervals of time.

**inert.** Gas that is inactive; not chemically reactive. Many shielding gases are inert.

**infrared rays.** Invisible rays emitted during welding; these rays can damage vision.

**insulation.** Material that does not allow for the easy flow of electricity.

**iron.** An elemental metal first smelted during the Middle Ages (15th to 17th century) as the early Bronze Age civilizations transitioned into the Iron Age. When alloyed with carbon, it forms steel. When mixed with slag, it becomes wrought iron (see **wrought iron**).

**joint.** The junction of edges to be joined during welding.

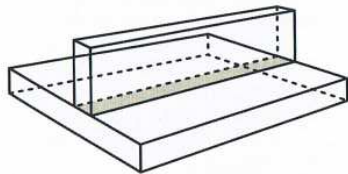
**lead (welding lead or work lead).**

A conductor that provides an easy path for electricity to flow.

**metal.** A solid material, typically hard, shiny, malleable, fusible, and easily shaped; a good conductor of electricity and heat. Metals normally have high luster and density, and can be deformed under stress without breaking.

**metallurgy.** The study of the physical and chemical behavior of metals and their mixtures (see **alloy**). It is also the technology of metals, including extraction from the ground and the manipulation of the mechanical properties by the application of heat (see **smelting**).

**microstructure.** The interaction of very small structures of metals and alloys generally not visible to the human eye except under 25 times magnification. The microstructure of a material can strongly influence physical properties such as strength, toughness, ease of shaping, and hardness.

**oxy-fuel welding and cutting.** Sometimes called oxyacetylene or gas welding and cutting, this process combines pressurized fuel gases (usually hydrogen, acetylene, or natural gas) with oxygen to form a high-intensity flame of up to 6,000 degrees Fahrenheit. The addition of a concentrated oxygen stream allows for efficient cutting of most iron that contains alloys.

**primary voltage shock.** An electrical shock from 120 to 480 volts that occurs in arc welding from touching a lead inside a switched-on welder and touching the welder case or other grounded metal at the same time.

**pulsed-spray.** Increasing and decreasing (pulsing) the welding current to control the properties of the electric arc and the transfer of filler.

**regulator.** A device controlling the amount of gas flow from a cylinder during a weld.

**secondary voltage shock.** An electrical shock from 60 to 100 volts that occurs in arc welding from touching the electrode while another part of the body touches the workpiece.



©American Welding Society, Welding Handbook, 9th ed., vol. 2

**shielded metal arc welding (SMAW).** Also known as stick welding. A manual arc welding process that uses a consumable electrode coated in flux to lay the weld. An electric current forms an electric arc between the electrode and the metals to be joined. As the weld is laid, the flux coating of the electrode disintegrates, giving off vapors that serve as a shielding gas, providing a layer of slag, which doubly protect the weld area from atmospheric contamination. Because of the versatility and simplicity of its equipment and operation, shielded metal arc welding is one of the world's most popular welding processes.

**shielding.** Protecting the weld metal from contamination by means of the decomposition of the flux coating the electrode. The electrode core wire and its covering supply the filler metal.

**short-circuiting transfer.** A method of transferring the filler metal from a wire welding process by a sequence of events in which the filler metal touches the base metal and then burns back to reestablish the welding arc.

**slag.** Cooled flux that forms on top of the weld bead. Slag protects the cooling metal and is then chipped off.

**smelting.** A form of extractive metallurgy used to produce a metal from the ore extracted from the ground.

**spatter.** Liquid metal droplets expelled from the welding process that can spray up to 35 feet from the work area.

**spray transfer.** A method of transferring the filler metal, typically from a wire welding process, across the arc in molten droplets, smaller than the diameter of the wire.

**steel.** An alloy of iron and small amounts of other elements such as carbon, manganese, chromium, vanadium, nickel, and tungsten.

**submerged arc welding (SAW).** An automatic welding process in which the electric welding arc is covered by a powdered flux. It is useful for filling joints in heavy plate and pipe. It is one of the most productive and popular welding processes.

**tensile strength.** The resistance to breakage exhibited by material when subjected to a pulling stress. The unit of tensile strength is the psi.

**thermoplastic.** A plastic that turns to liquid when heated, and freezes when cooled. Thermoplastic differs from thermosetting plastic, which can be remelted and remolded.

**ultraviolet rays.** Harmful invisible rays emitted by the arc during welding that can damage a welder's vision and burn skin.

**ventilation.** A means of providing fresh air for the welder's safety.

**weldability.** The capacity of material to be welded under imposed fabrication conditions into a specific, suitably designed structure and to perform satisfactorily in the intended service.

**welding.** The process of joining metals or thermoplastics by fusion. This is often done by melting the workpieces and adding a filler material to form a pool of molten material (the weld pool) that cools to become a strong joint.

**welding helmet.** A protective eye and face device worn by the welder for protection from the arc's harmful rays and intensely bright light. Sometimes called welding shield.

**welding screen.** A large fire-resistant screen placed around a weld area to protect bystanders and to block stray spatter.



**weldment.** An assembly of component parts joined by welding.

**weld pool.** The molten metal in a weld prior to its solidification as weld metal.

**weld root.** The point at which the weld metal extends farthest into a joint and intersects the base metal.

**welder's flash.** An extremely painful condition that can result from exposure to UV rays. It can feel like sunburn on the eye and is usually a temporary condition.

**work cable.** The path used in welding to conduct electricity from the welder to the workpiece. To prevent injury, the work cables must be correctly installed and in good condition.

**workpiece.** The part that is welded, brazed, soldered, thermally cut, or thermally sprayed.

**wrought iron.** A pure form of iron mixed with slag, creating a fibrous material with the appearance of a "grain" resembling wood that is visible when etched or bent to the point of failure. Wrought iron is tough, malleable, ductile, and easily welded.

## Welding Resources

The resources listed below represent only a fraction of available welding information. Check your local library, bookstores, and the Internet for additional titles, including older or out-of-print books. Most welding techniques are timeless.

### Scouting Resources

*Drafting, Electronics, Engineering, First Aid, Inventing, Metalwork, Robotics, and Safety* merit badge pamphlets

With your parent's permission, visit the Boy Scouts of America's official retail website at [www.scoutstuff.org](http://www.scoutstuff.org) for a complete list of all merit badge pamphlets and other Scouting materials and supplies.

### Books

American National Standards Institute (ANSI) Accredited Standards Committee Z49. *Safety in Welding, Cutting, and Allied Processes*. ANSI Z49.1:2005. American Welding Society, 2005.

American Welding Society. *Welding Handbook, Vol. 1*, 9th ed. American Welding Society, 2001.

———. *Welding Handbook, Vol. 2*, 9th ed. American Welding Society, 2004.

———. *Welding Handbook, Vol. 3*, 9th ed. American Welding Society, 2007.

Minnick, William H. *Gas Tungsten Arc Welding Handbook*, 5th ed. Goodheart-Willcox Company, 2005.

O'Brien, Robert L. *Jefferson's Welding Encyclopedia*, 18th ed. American Welding Society, 1997.

### Organizations and Websites

#### American Welding Society

Website: [www.aws.org](http://www.aws.org)

#### ESAB Education Resources

Website: [www.esabna.com/us/en/education/index.cfm](http://www.esabna.com/us/en/education/index.cfm)

#### Hobart Institute of Welding Technology

Website: [www.welding.org](http://www.welding.org)

#### James F. Lincoln Arc Welding Foundation

Website: [www.jflf.org](http://www.jflf.org)

#### Lincoln Electric Company

Website: [www.lincolnelectric.com](http://www.lincolnelectric.com)

#### Miller Electric Manufacturing Company

Website: [www.millerwelds.com/resources/](http://www.millerwelds.com/resources/)

#### Thermadyne Industries Inc.

Website: <http://thermadyne.com>

**Photo and Illustration Credits**

American Welding Society, courtesy—pages 6, 9, 13 (*bottom*), 15, 25 (*bottom*), 28, 29, 31 (*top right, middle, and bottom right*), 34, 35 (*top right, both bottom*), 38 (*top*), 39 (*bottom*), 47, 56 (*bottom*), 57, 58 (*both*), 59, 72, 83, 85, and 88

David Landon, courtesy—pages 14, 17, 18, 19, 24, 25 (*top*), 55 (*bottom*), 75 (*plans*), and 79 (*plans*)

Library of Congress Prints & Photographs Division, courtesy—page 8

Lincoln Electric Company, Cleveland, Ohio, USA, courtesy—pages 3, 21 (*bottom*), 23 (*both*), 30, 37, 38 (*bottom*), 39 (*top*), 66, 70 (*all*), and 71 (*center*)

Thermadyne Industries Inc., courtesy—page 31 (*bottom left*)

Thinkstock—pages 13 (*top*) and 56 (*both top*)

Thinkstock/John Foxx—page 5

U.S. Navy/Ridge Leoni, courtesy—page 68

U.S. Navy/Andrew McKaskle, courtesy—page 81

Jean Woodham, courtesy—page 80

All other photos and illustrations not mentioned above are the property of or are protected by the Boy Scouts of America.

John McDearmon—all illustrations on pages 33, 36, 40, 41, 43, 45, 48, 49, 52–54, 61–62, 69, 71, and 84

**American Welding Society**

The American Welding Society has published guidelines, definitions, and facts to help you gain knowledge about being safe while welding. This information can be downloaded for free at [www.aws.org/technical/facts](http://www.aws.org/technical/facts). Further information about welding safety can be found at the American Welding Society's website at [www.aws.org](http://www.aws.org).

**Acknowledgments**

This edition of the *Welding* merit badge pamphlet was written by a special committee to the Professional Development Council of the American Welding Society. Members of the committee include:

- David Landon, Vermeer Corporation—committee chair and vice president, American Welding Society
- Jack Compton (retired), College of the Canyons
- Richard Harris, retired editor, *Welding Design & Fabrication* magazine
- J. Jones, Thermadyne Industries
- Roy Lanier, Pitt Community College
- Dennis Marks, American Welding Society
- Neil Shannon, Carlson Testing

**MERIT BADGE LIBRARY**

Though intended as an aid to Boy Scouts, Varsity Scouts, and qualified Venturers and Sea Scouts in meeting merit badge requirements, these pamphlets are of general interest and are made available by many schools and public libraries. The latest revision date of each pamphlet might not correspond with the copyright date shown below, because this list is corrected only once a year, in January. Any number of merit badge pamphlets may be revised throughout the year; others are simply reprinted until a revision becomes necessary.

If a Scout has already started working on a merit badge when a new edition for that pamphlet is introduced, *he may continue to use the same merit badge pamphlet to earn the badge and fulfill the requirements therein*. In other words, the Scout need not start over again with the new pamphlet and possibly revised requirements.

Merit Badge Pamphlet	Year	Merit Badge Pamphlet	Year	Merit Badge Pamphlet	Year
American Business	2002	Entrepreneurship	2006	Pioneering	2006
American Cultures	2005	Environmental Science	2006	Plant Science	2005
American Heritage	2005	Family Life	2005	Plumbing	2004
American Labor	2006	Farm Mechanics	2008	Pottery	2008
Animal Science	2006	Fingerprinting	2003	Public Health	2005
Archaeology	2006	Fire Safety	2004	Public Speaking	2002
Archery	2004	First Aid	2007	Pulp and Paper	2006
Architecture and Landscape Architecture	2010	Fish and Wildlife Management	2004	Radio	2008
Art	2006	Fishing	2009	Railroading	2003
Astronomy	2010	Fly-Fishing	2009	Reading	2003
Athletics	2006	Forestry	2005	Reptile and Amphibian Study	2005
Automotive Maintenance	2008	Gardening	2002	Rifle Shooting	2001
Aviation	2006	Genealogy	2005	Robotics	2011
Backpacking	2007	Geocaching	2010	Rowing	2006
Basketry	2003	Geology	2005	Safety	2006
Bird Study	2005	Golf	2002	Salesmanship	2003
Bugling (see Music)		Graphic Arts	2006	Scholarship	2004
Camping	2005	Hiking	2007	Scouting Heritage	2010
Canoeing	2004	Home Repairs	2009	Scuba Diving	2009
Chemistry	2004	Horsemanship	2010	Sculpture	2007
Chess	2011	Indian Lore	2008	Shotgun Shooting	2005
Cinematography	2008	Insect Study	2008	Skating	2005
Citizenship in the Community	2005	Inventing	2010	Small-Boat Sailing	2004
Citizenship in the Nation	2005	Journalism	2006	Snow Sports	2007
Citizenship in the World	2005	Landscape Architecture (see Architecture)		Soil and Water Conservation	2004
Climbing	2011	Law	2003	Space Exploration	2004
Coin Collecting	2008	Leatherwork	2002	Sports	2006
Collections	2008	Lifesaving	2008	Stamp Collecting	2007
Communication	2009	Mammal Study	2003	Surveying	2004
Composite Materials	2006	Medicine	2009	Swimming	2008
Computers	2009	Metalwork	2007	Textile	2003
Cooking	2007	Model Design and Building	2010	Theater	2005
Crime Prevention	2005	Motorboating	2008	Traffic Safety	2006
Cycling	2003	Music and Bugling	2003	Truck Transportation	2005
Dentistry	2006	Nature	2003	Veterinary Medicine	2005
Disabilities Awareness	2005	Nuclear Science	2010	Water Sports	2007
Dog Care	2003	Oceanography	2009	Weather	2006
Drafting	2008	Orienteering	2003	Welding	2012
Electricity	2004	Painting	2008	Whitewater	2005
Electronics	2004	Personal Fitness	2006	Wilderness Survival	2007
Emergency Preparedness	2008	Personal Management	2003	Wood Carving	2006
Energy	2005	Pets	2003	Woodwork	2011
Engineering	2008	Photography	2005		

**BOY SCOUTS OF AMERICA • SUPPLY GROUP****NATIONAL DISTRIBUTION CENTER**

2109 Westinghouse Boulevard  
P.O. Box 7143  
Charlotte, NC 28241-7143

[www.scoutstuff.org](http://www.scoutstuff.org)

**DIRECT MAIL CENTER**

P.O. Box 909  
Pineville, NC 28134-0909

For fast credit card orders—  
VISA, MasterCard, American Express—  
call BSA operators toll-free  
1-800-323-0732