

# METALWORK



BOY SCOUTS OF AMERICA  
IRVING, TEXAS

## Note to the Counselor

The Metalwork merit badge offers Boy Scouts a fun way to explore four metalworking disciplines. The four options in this pamphlet were selected because they can be offered at any Boy Scout summer camp that schedules five two-hour sessions for this merit badge. Many professionals in these four disciplines continue to practice their trade with a minimal use of power tools.

There is no need to make all four metalworking options available during a Scout's summer camp experience. If finding a counselor for each of the options proves to be too difficult, or if providing all of the tools and materials is too costly, select one option and *do it well*.

The projects in this pamphlet are offered as guidelines only. If you have favorite projects that can be readily completed by Scouts, feel free to use them. You are encouraged to help enrich each Scout's experience by drawing upon your professional knowledge and experience, but remember that a merit badge counselor may neither add nor delete requirements, nor simplify or make requirements more difficult than stated.

Scouts working on this merit badge require direct adult supervision. A sheet metal burr can cause a cut, molten pewter and orange-hot steel can cause severe burns, and the sulfuric acid used by silversmiths to pickle their silver can be dangerous to anyone if used improperly.

Some of the tools described in this merit badge pamphlet are those collected by professional metalworkers throughout their years of experience. To earn this merit badge, Scouts need only learn to use a few basic tools that they should be able to borrow from a more experienced metal worker. If a Scout develops greater interest in the craft and desires to further the hobby outside the requirements of the Metalwork merit badge, he can begin to collect his own set of tools.

# Requirements

1. Read the safety rules listed in the *Metalwork* merit badge pamphlet. Describe to your counselor how to be safe while working with metal. Because this merit badge offers four options, show your counselor which additional safety rules apply to the discipline you choose and discuss them with your counselor.
2. Do the following:
  - a. Define the term **native metal**.
  - b. Define the term **malleable**.
  - c. Define the term **metallurgy**.
  - d. Define the term **alloy**.
  - e. Name two **nonferrous** alloys used by pre-Iron Age metalworkers, and name the metals that are combined to form these alloys.
  - f. Explain the term **ferrous**, and name three ferrous alloys used by modern metalworkers.
  - g. Describe how to **work-harden** a metal.
  - h. Describe how to **anneal** a nonferrous and a ferrous metal.
3. Do the following:
  - a. Put a 45-degree bend in a small piece of unworked 26- or 28-gauge sheet brass or sheet copper. Note the amount of effort that is required to overcome the yield point in this unworked piece of metal.
  - b. Work-harden another piece of the same sheet brass or sheet copper, and then put a 45-degree bend in it. Note the amount of effort that is required to overcome the yield point.

- c. Soften the same bent, work-hardened piece by annealing it, and then try to remove the 45-degree bend. Note the amount of effort that is required to overcome the yield point.
  - d. Join two small pieces of scrap metal using a hammered rivet. Repeat the process using a pop rivet.
  - e. Using a flatlock seam, join two pieces of scrap metal together with either lead-free solder or silver solder.
  - f. Make a temper color index from a flat piece of steel. Using hand tools, make and temper a center punch of medium-carbon or high-carbon steel.
  - g. Using metal cans, practice using the basic metalworking tools and techniques by making at least two tasteful objects that require cutting, bending, and edging.
4. Do ONE of the following:
- a. Visit an experienced sheet metal mechanic, tinsmith, coppersmith, silversmith, jeweler, founder, or a blacksmith at his or her workshop. You may select a skilled hobbyist or a professional. Ask permission to see the tools used and to examine examples of the work made at the shop. Inquire about the level of education required to become an apprentice craftsman.
  - b. If you have (or your counselor has) access to the Internet, explore metalworking occupations by conducting a Web search. With your counselor's help and guidance, find at least five metalworking-related Web sites. Print a copy of the Web pages and discuss them with your counselor.

When conducting your Web search, use keywords such as *metallurgy, metalwork, spinning metal, metal fabrication, steel fabrication, aluminum fabrication, casting metal, pattern making, welding, forge welding, blacksmith, art metal, Artist Blacksmith Association of North America, farrier, brazing, goldsmith, machinist, or sheet metal mechanic.*

5. After completing the first four requirements, complete at least ONE of the options listed below.

**a. Option 1—Sheet Metal Mechanic/Tinsmith**

- 1) Name and describe the use of the basic sheet metal-working tools.
- 2) Create a reasonably accurate sketch of two tasteful objects to make from sheet metal. Include each component's dimensions on your sketch.
- 3) Using patterns provided either by your counselor or made by you, make at least two tasteful objects out of 24- or 26-gauge sheet metal. Use a metal that is appropriate to the object's ultimate purpose.
  - a) Both objects must be constructed using cutting, bending, edging, and either soldering or brazing.
  - b) One object also must include at least one riveted component.
  - c) If you do not make your objects from zinc-plated sheet steel or tin-plated sheet steel, preserve your work from oxidation.

**b. Option 2—Silversmith**

- 1) Name and describe the use of the basic tools used by a silversmith.
- 2) Create a reasonably accurate hand-drawn sketch of two tasteful objects to make from sheet silver. Include each component's dimensions on your sketch.
- 3) Using patterns either provided by your counselor or made by you, make at least two tasteful objects of 18- or 20-gauge sheet copper. If you have prior silversmithing experience, you may substitute sterling silver, nickel silver, or lead-free pewter.
  - a) At least one object must include a sawed component you have made yourself.
  - b) At least one object must include a sunken part you have made yourself.
  - c) Both objects must include a soldered joint.
  - d) Clean and polish your objects.

**c. Option 3—Founder**

- 1) Name and describe the use of the basic parts of a two-piece mold. Name at least three different types of molds.
- 2) Create a reasonably accurate sketch of two tasteful objects to cast in metal. Include the height, width, and length on the sketch.
- 3) Do the following:
  - a) Using a pattern provided by your counselor and another one you have made yourself, make two molds. Position the pouring gate and vents yourself. *Do not use copyrighted materials as patterns.*

- b) Make a casting using a mold provided by your counselor *and* make a casting using the mold that you have made. Use lead-free pewter when casting each mold.
- c) Remove all evidence of gates, vents, and parting-line flash from your castings.

**d. Option 4—Blacksmith**

- 1) Name and tell the use of the basic tools used by a blacksmith.
- 2) Make a reasonably accurate sketch of two tasteful objects to hot-forged. Include each component's dimensions on your sketch.
- 3) Using low-carbon steel at least 1/4-inch thick, perform the following exercises:
  - a) Draw out by forging a taper.
  - b) Use the horn of the anvil by forging a U-shaped bend.
  - c) Twist steel by placing a decorative twist in a piece of square steel.
  - d) Use the edge of the anvil to bend metal by forging an L-shaped bend.
- 4) Using low-carbon steel at least 1/4-inch thick, make at least two tasteful objects that require hot-forging.
  - a) Include a decorative twist on one object.
  - b) Include a hammer-riveted joint in one object.
- 5) Preserve your work from oxidation.

33312B  
ISBN 0-8395-3312-8  
©2001 Boy Scouts of America  
2006 Printing



## Contents

Introduction . . . . .	10
The Sheet Metal Mechanic/Tinsmith . . . . .	32
The Silversmith . . . . .	43
The Founder . . . . .	53
The Blacksmith . . . . .	64
Glossary . . . . .	73
Metalwork Resources . . . . .	78

# Introduction

Becoming a master metalworker does not happen overnight. Learning the skills and techniques used by metalworkers requires lots of practice and knowledge of the basics.

You will begin your work on this merit badge by learning about the properties of metal, how to use the fundamental metalworking tools, and the basic metalworking techniques. You will then practice using these tools and techniques by turning metal cans into art objects or useful gadgets. Afterward, you will expand your knowledge by studying more intricate skills of one of the four metalworking options offered for the Metalwork merit badge:

- Sheet metal mechanic/tinsmith
- Silversmith
- Founder
- Blacksmith

Sheet metal mechanics, or tinsmiths, work by bending thin sheets of metal then soldering the component parts together. Silversmiths hammer and cut thin sheets of metal into gracefully shaped components and then solder the parts together. Founders pour molten metal into molds to make a finished piece. Blacksmiths use fire, water, and steel to hammer out fanciful and useful objects. All four of these metalworking techniques can create art objects of great beauty as well as useful objects that meet a practical need. The choice is yours!

## The History of Metal

Working metal is one of humankind's oldest skills. When prehistoric man discovered metal in its natural state and then found that he could change its shape by hitting it with a hammer, he became the world's first metalsmith.

## The Copper Age

During the late Stone Age, between 7000 B.C. and 6000 B.C., humans in Anatolia (a region in modern-day Turkey) learned to create useful items from native copper they had found. *Native metals* are those that occur naturally in a nearly pure form. Copper is a *nonferrous* metal—one that does not contain iron—that occasionally can be found in a native state. Other nonferrous metals that occur naturally are gold, silver, and tin.

About a thousand years later, our ancestors began to melt native metals. Placing the lumps of metal in a *crucible*, a container that resists high heat, they would melt the metal and then pour a stream of molten metal into crude two-piece clay molds.

## ORE-BEARING ROCKS

Trade values increased the demand for metal objects and forced early metalworkers to look for additional sources of metal. They found one solution in *ore-bearing rocks*.

It is unknown how our ancestors discovered that certain rocks leave a small amount of metal behind when they are melted in extremely hot fires. Today, this process—called *smelting*—is a large part of the metal industry. Smelting iron from ore probably began in China and India around 4000 B.C. and then spread westward to the area around the Black Sea.

Yet another important discovery of this era was the creation of *alloys*—metals mixed with other metals or other substances to change the properties of the metal. Silversmiths began to add a small amount of copper to silver, and goldsmiths began to add small amounts of silver and copper to gold, which reduced the *ductility* of these two very soft metals, making them less likely to deform—and much more useful.

## The Bronze Age

The Bronze Age began in China around 3300 B.C., when smiths began creating tools with a strong alloy made by adding tin to copper. The result was bronze—a metal with such reduced ductility that it could be fashioned into tools strong enough to cut blocks of limestone and granite. By 2500 B.C., the technique had spread throughout India and to the eastern Mediterranean countries.

## CASTING EMERGES

Throughout the early ages of metalworking, smiths could create objects by heating metal and hammering it on an *anvil*. As their knowledge of metal increased, they found that molten metal could be *cast* into a hollow mold.

Initially, molds were made of clay. As metalworkers in countries in eastern India, China, and along the Mediterranean Sea developed their casting skills, better types of molds emerged. Some types of molds, including hard-packed sand molds and ceramic molds, are still being used.

## The Iron Age

Soon after people discovered that they could smelt ores, the production of iron began. Because iron ore is more abundant than copper ore, iron can be produced in larger quantities and at lower cost than copper. Smiths began to create iron pieces such as cooking kettles, which quickly became popular because of their availability and usefulness. Because of its low production cost and high demand, iron became known as the “democratic” metal.

## The Discovery of Steel

Metalworkers in India and Japan independently discovered how to make *steel* in about A.D. 600. To create this strong alloy, iron and carbonaceous material (charcoal, sawdust, or other matter that contains the element carbon) were mixed in a crucible and heated in a forced-draft furnace long enough for the iron pieces to melt and absorb the carbon gas produced by the carbonaceous matter. The result was a steel disk, called a “cake,” which blacksmiths then forged into bars that could be used as trade goods.

Because steel is less ductile and *malleable*—capable of being shaped with tools—than iron, a blacksmith has to work harder to make something out of steel than out of iron. Objects made of steel are much less likely to bend or deform than items made of iron, and by controlling the amount of carbon introduced during the production stage, steels of varying hardness can be manufactured.

## CARBON STEELS

*Steel* is iron that contains less than 2 percent carbon. Low-carbon steel contains up to 0.25 percent carbon. Medium-carbon steel contains between 0.25 and 0.55 percent carbon. High-carbon steel contains more than 0.55 percent carbon, but today's usual upper limit is about 1.20 percent carbon. Carbon steels contain iron as the only metal in their composition.

The steel that is most often used by today's blacksmiths and sheet metal mechanics contains between 0.08 to 0.23 percent carbon. Modern industry uses one of the medium-carbon steels to make most hand tools. If an item must hold a sharp edge for a long time, such as a pocketknife or an ax, then one of the high-carbon steels is used. The drawbacks to making something from high-carbon steel are lost flexibility and the chance that the item may snap if twisted.

## ALLOY STEELS, STAINLESS STEELS, AND BEYOND

Until the invention of the steam engine, wrought iron and carbon steel served quite well. As the use of steam-powered machinery caught on with industry during the 19th century, each new model of steam engine produced greater power. These increasingly more powerful engines placed more demands upon their metal components, so the engineers who designed steam engines began to demand stronger and tougher new alloys, especially ferrous alloys. They turned to *metallurgists*—scientists who study the properties of metals—to help meet their demands.

The metallurgists began to experiment by adding small amounts of other metals to carbon steel, creating alloy steels. The metallurgists invented alloys that were increasingly more ductile, stronger, harder, tougher, resistant to wear, and resistant to corrosion.

Rising demands by industrial consumers of steel, such as the producers of automobiles and manufacturing equipment, have led to the development of many new varieties of steel. Modern steel companies produce an average of 200 to 300 different steel grades to supply the demands of these applications.





**Always wear the proper safety gear when working with metal.**

## The Basics of Metalworking

Unlike some other skills used by modern workers, metalworking requires the craftsman to pay close attention to the work at hand and to adhere closely to special safety requirements. Before diving into the techniques of metalworking, learn how to keep yourself and others safe while working with metal.

### Safety Rules

When working with metal, acid, and high temperatures, metal workers should be aware of possible hazards, and Scouts must have adult supervision. Following the rules will keep metalworking safe and enjoyable.

### SHEET METAL SAFETY

Paying attention to what you are doing and wearing the proper gear is critical in metalworking. When sheet metal is cut, a small chip of metal may fly anywhere—possibly into your eye. Sharp edges on metal can cause cuts. Hot metal can cause painful burns. The rules listed below apply to all four metalworking options.

1. Always work with direct adult supervision.
2. Always wear safety goggles or safety glasses, leather gloves, and a shop apron.
3. Handle sheet metal with care. It can cause serious cuts.
4. Treat every cut immediately, no matter how minor.
5. Remove all burrs from the sheet metal before attempting further work on it.
6. Use a brush—not your hands—to clean the work area.
7. Do not run your hands over the surface of sheet metal that has just been cut or drilled. The burrs can cut.

8. Place scrap pieces of sheet metal in a scrap box right away.
9. Do not use tools that are not in first-class condition. Avoid hammers with loose handles or chisels with worn or misshapen heads.
10. Use a broom and a dustpan to sweep the shop floor. Do not leave slivers of metal on the worktable or the shop floor.

### **SAFETY WITH THE PICKLING TANK**

If you select the silversmith option to complete your Metalwork merit badge, you have additional safety rules to learn. Follow these guidelines when using the pickling tank, an integral step in the silversmithing process.

1. Always use the pickling tank with adult supervision.
2. Always wear eye protection, a shop apron, and rubber gloves when working with the pickling tank and solution.
3. Use the pickling tank in a well-ventilated space, and do not breathe fumes from the pickling solution.
4. Never pour water into the pickling tank solution; pour the pickling solution into the water.
5. Keep small children and pets away from the pickling tank.
6. Always store the pickling tank with its lid tightly secured.
7. Plainly mark the contents of the pickling tank.

### **SAFETY WITH MOLTEN PEWTER**

If you select the founder option to complete your Metalwork merit badge, you will be working with molten pewter. You must know a few more safety rules:

1. Always work with direct adult supervision.
2. Have at least one fire extinguisher handy when using the melting pot.
3. Place a sheet of metal under the melting pot and the mold-pouring area to prevent accidental splatters from burning your worktable.

4. Wear safety glasses, leather gloves, long pants, boots, and a shop apron when pouring metal. Be sure to pull your pant legs down over the top of your boots. Do not wear shorts, sandals, or water shoes.
5. Do not set a pouring ladle down with its handle extending past the edge of the workbench.
6. Do not put moist or wet metal in the melting pot. Bubbles caused by escaping steam will cause the molten metal to splash out of the crucible, possibly causing painful burns.
7. Do not eat while casting metal.
8. Always wash your hands after handling metal.

### **SAFETY WITH HOT STEEL**

If you choose the blacksmith option to complete your Metalwork merit badge, you will be working with orange- or yellow-hot steel. Here are some special rules that you must follow:

1. Always work with direct adult supervision.
2. Have at least one fire extinguisher handy at all times.
3. Wear safety glasses, leather gloves, a shop apron, long pants, and boots when working in a blacksmith shop. Be sure to pull your pant legs down over the tops of your boots. Do not wear shorts, sandals, or water shoes.
4. Put hot metal in an out-of-the-way place to cool.
5. Use tongs to pick up a dropped object. Although it might not glow, it may still be 1000 degrees.

### **Tools and Materials**

The following are the tools and materials that can be used to complete requirements 3a through 3f. The basic techniques are explained in this chapter, and step-by-step instructions for projects that employ these techniques are given in later chapters.



## TOOLS

- Sheet metal snips
- Various patterns
- Machinist's vise
- Center punch
- Flat-faced wooden mallet
- Pipe anvil
- Iron pipe of about 2-inch outside diameter
- Hand seamer
- Hemmer
- Lineman's, needle-nosed, and locking-jaw pliers
- Wood blocks, in pairs
- Two C-clamps
- Flat file with handle
- 12-ounce ball peen hammer
- ½-inch cold chisel
- Hacksaw and spare blades
- Pop rivet gun
- Rivet set
- Propane torch
- 125-watt or 150-watt electric soldering iron
- Steel dividers
- Folding rule or measuring tape
- Carpenter's square (or equivalent)
- Metal straightedge
- Scriber
- Drill press
- Drill bits (sized to match the pop rivets)
- Shop apron
- Leather gloves
- Safety glasses

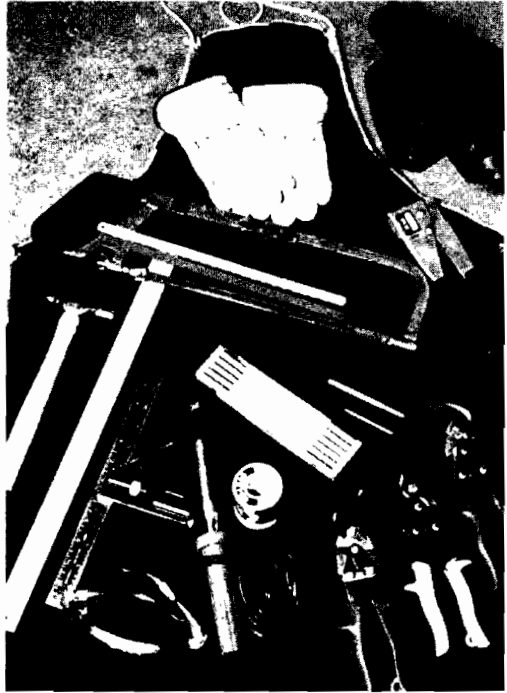

## MATERIALS

- Lead-free solder
- Variety of family-size metal food cans (avoid institutional-size food cans; they are too large to make the projects in this pamphlet)
- Two or three tenpenny nails
- Two or three pop rivets
- Two 3-by-3-inch pieces of 24- or 26-gauge copper or brass (not steel or aluminum)
- One 5-inch piece of  $\frac{3}{8}$ -inch (round or square) medium-carbon or high-carbon steel (C1065, W1, or equivalent)
- Clothes hanger wire
- Five or six small blocks of scrap 2-by-4-inch lumber of different lengths
- One 6-inch flat steel scrap
- Soapstone pencil

### Springback

Cold metal does not always stay in place after it is bent. To overcome the *springback* effect, the metal often must be bent past its *yield point*. An experiment will illustrate this idea.

Place a thin piece of sheet brass or sheet copper that has never been worked between two pieces of wood, leaving enough metal clear of the top so you can press against it with your hand. Clamp the wood and metal tightly into a vise. Without using any tools, do your best to put a 45-degree bend in the unworked metal. Stop when you have pushed the metal to 45 degrees. *Do not overbend the metal.* When you let go, the angle of the metal will adjust itself to something less than 45 degrees. That effect is springback.

### Work Hardening

The process of hardening a metal by hammering it is called *work hardening*. All metals except mercury and lead become harder as they are hammered. As a metal is work hardened, it becomes more resistant to change its shape. The metal must be softened—or *annealed*—from time to time during the work hardening process or it will rupture or crack.

Another experiment provides an example of work hardening. Hit a small piece of thin sheet brass or sheet copper repeatedly with the domed end of a ball peen hammer. Place your blows closely together, covering the work with small dents.

This peening process causes the *crystals* that form the metal to condense with each blow. The closer the crystals are to each other, the stiffer the metal becomes.

## Annealing

Metal is *annealed* by heating it to the temperature where it is soft enough for the metalworker to continue to shape the piece. How long a piece of metal is exposed to the critical temperature depends on its thickness and shape.

### ANNEALING FERROUS METALS

Most ferrous alloys must be cooled slowly after being elevated to their critical temperature. Failure to slowly cool high-carbon steel makes it brittle. Metal that is brittle tends to crack easily. This is referred to as being “glass hard.”

High-carbon steel is annealed by being heated to a bright cherry red heat (about 1350 degrees) and then being cooled slowly in a metal box insulated with wood ashes or vermiculite (clean cat litter). The piece must be cooled for at least eight hours before it is worked again.

## Measuring the Thickness of Metal

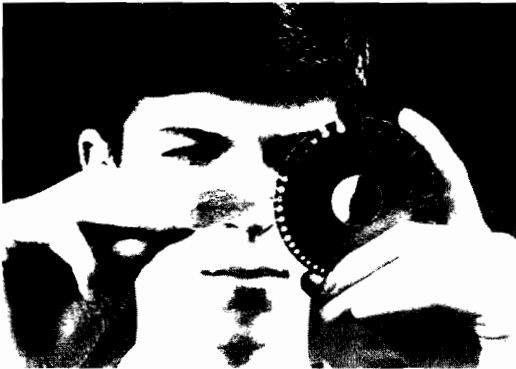

In the United States, the thickness of sheet metal and wire is measured with a thickness gauge—one for ferrous metal and another for nonferrous metal. The system runs from 0—about the diameter of a pencil—to 36—finer than a

human hair. The numbers run consecutively, although even-numbered gauges are used most often. Twenty-gauge sheet steel is 0.035 inch thick, while 20-gauge nonferrous metal is 0.032 inch thick.

---

Use only lead-free solder. Although lead-tin solder is still available, it releases toxic fumes. Over time, inhaling these fumes can cause brain damage. Eating or drinking from utensils made of lead-tin solder also can cause brain damage.

---

## ANNEALING NONFERROUS METALS

Nonferrous metals are annealed by bringing them to a cherry red heat, allowing them to cool until the color disappears, and then quenching them in a pickling solution. For copper, brass, and silver, cherry red heat ranges from 660 degrees to 1100 degrees, depending on the alloy. Unlike ferrous metals, nonferrous metals do not become brittle if cooled immediately after reaching critical temperature. This permits a metalworker to quickly continue working.

## Riveting

A *rivet* is a mechanical fastener that is hammered into place. Factory-made rivets are available in a variety of sizes. Common nails can be used as rivets if they are cut to the correct length and the shank is peened down. While the nail head is flat instead of round like a rivet, it will hold adequately.

## Soldering and Brazing

*Soldering* and *brazing* are methods of joining metals with melting nonferrous metal filler without having to heat the base metal to its *melting point*. The method used depends on the metals involved in projects.

Before two metals can be joined by soldering or brazing:

1. The surfaces to be soldered or brazed must be clean.
2. An adequate source of heat must be available.
3. The correct solder or brazing alloy must be used.
4. The proper *flux* must be applied.

## SOLDER

*Solder* is a metal filler that is melted to join two pieces of metal. By definition, soldering occurs at temperatures less than an arbitrary 800 degrees. Use lead-free solder when joining tin-plated steel and thin sheet steel.

## Silver Solder

Silver solders are brazing materials that melt at temperatures higher than 800 degrees. When working with silver, always use silver solder rather than regular solder. Silver solder can be made to flow using a propane torch.

The chart shows the five categories of silver solder:



Type of Solder	Flow Temperature
Extra-easy-flow silver	1200 degrees
Easy-flow silver	1300 degrees
Medium-flow silver	1360 degrees
Hard-flow silver	1460 degrees
IT silver (high-temperature solder)	1490 degrees

Having all five types of silver solder handy is smart when assembling pieces of a complex project. The first solder joint should use the highest-temperature silver solder available. Subsequent joints should use the remaining solders in declining temperature order as the subsequent components are attached. This way the first joint will not come apart as the next joints are soldered.

## FLUX

All metals oxidize when exposed to air, especially humid air. The thin layer of tarnish or rust that results must be removed before solder will stick to a metal. A chemical mixture called *flux* is applied to the joint to remove these oxides and prevent further oxidizing while the metal is heated to the soldering temperature. Flux also lowers the surface tension of the molten solder, making it flow more easily.

---

To cut a hole in sheet metal, first use a hollow punch to make a small hole inside the diameter of what will become the large hole.

Then insert the tip of the snips into the punched hole. Cut in a circular pattern until the layout line is reached. Follow the layout line to complete the cut.

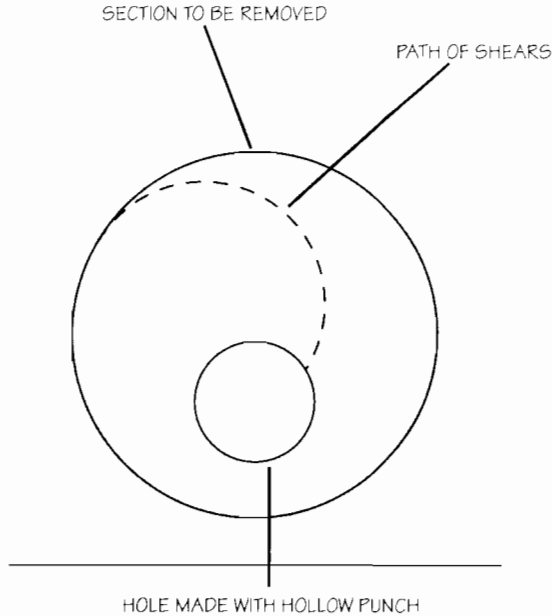

### Cutting a hole in sheet metal

---

## Cutting

Use hand-held sheet metal shears to make projects. These shears are manufactured with right-cutting, left-cutting, and combination jaws. Hold the shear and look down the blade to determine which kind of shear you have. If the blade curves to the right, it is a right-cutting shear. If the blade curves to the left, it is a left-cutting shear. If the blade does not curve at all, it is a combination shear that can be used to make straight as well as circular cuts.

## Edging

The small band of metal that runs around the top edge of a modern metal can is a machine-made *hem* or a “safe edge.” Because a cut edge is too sharp to be left in a finished piece, a careful sheet metal mechanic will put a hem in the edge for safety.

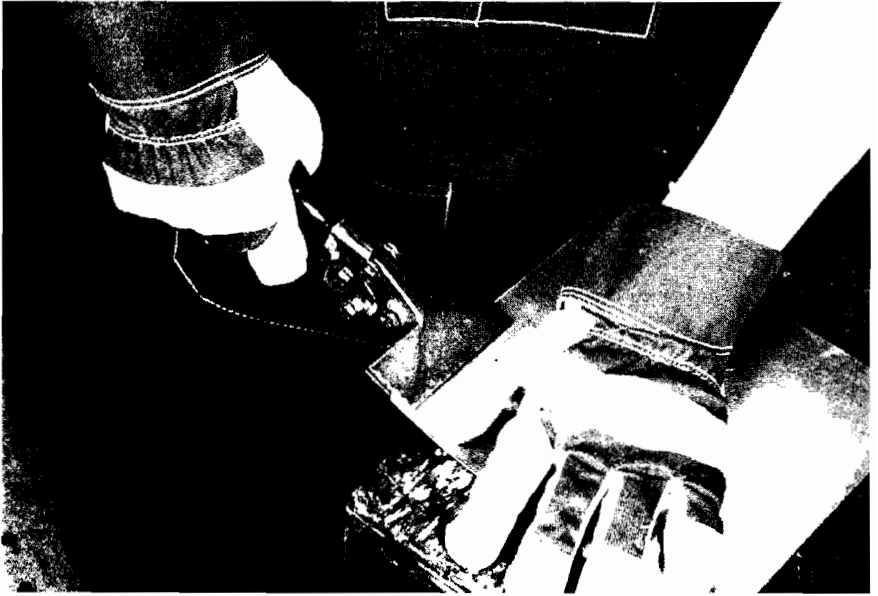

Use a hand seamer to make bends. To bend a safe edge, place  $\frac{3}{16}$  inch of metal in the seamer's jaws.

## Bending

A bar former is used to make bends in small sheet metal sections, and a bending break is used to make bends in large sheet metal sections. Both tools can be set up to make 90-degree and 45-degree angles as well as curved bends. If there is no access to a bar former or a bending break, clamp sheet metal between two wooden blocks or between two steel bars and use a wooden mallet to make the bend. Or, if your projects are small, use a hand seamer to make bends.

## Seaming

*Seaming* is the process of joining two pieces of metal as if by sewing. The flatlock seam is most commonly used when making an item from sheet metal. When designing a piece, allow for extra metal on the edges to make the seams.

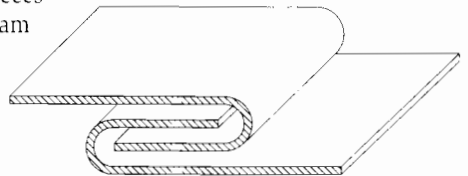

## Rolling

*Rolling* is a technique that allows the metalworker to create rounded shapes easily. A slip-form roller can be used to shape sheet metal into a cylinder. You can also gently hammer the metal over the edges of an anvil or over a piece of iron pipe.

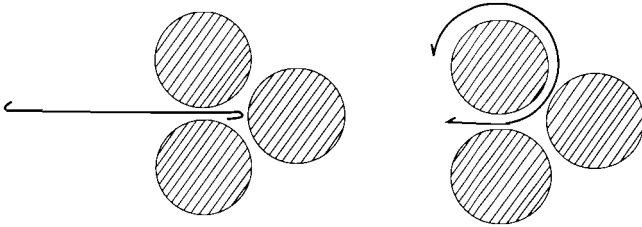

**A slip-form roller can be used to make curved shapes such as cones and cylinders. Notice in the diagram that the edges of the seams have already been bent and are facing opposite directions.**

**When using the horn of the anvil to roll sheet metal, don't hit straight down on the metal where it touches the anvil. Position the blows to avoid denting and crimping the sheet metal.**

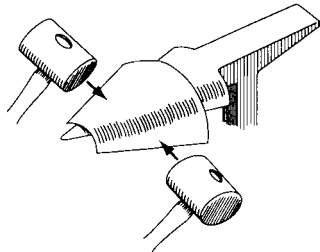

## Tempering

Unlike iron, steel can be hardened to the point that it becomes brittle and fractures easily. To make it useful, its brittleness must be relaxed enough to make the steel capable of holding an edge without snapping when flexed. This relaxing technique is called *tempering*.

Tempering is done in two steps. First, the steel is made brittle by being heated to its critical temperature (between 1350 and 2400 degrees, depending on the alloy and the carbon content) and then being cooled rapidly by plunging into pickling bath or water, depending on the metal.

The second step is the real tempering step. The brittleness is relaxed by applying just the right amount of heat to achieve the correct degree of hardness needed to make the tool function properly. A temper color index will help determine the degree of hardness desired.



## MAKING A TEMPER COLOR INDEX

Because this pamphlet is printed in black and white, it is impossible to depict the colors used to judge temperatures when tempering. Making a temper color index will help you decide when a metal has reached the desired temperature.

**Step 1**—Saw a piece of flat steel about 5 to 6 inches long.

**Step 2**—Sand or file one side of the bar until it is bright and shiny.

**Step 3**—Firmly clamp one end of the steel in a pair of locking-jaw pliers, leaving 4 inches free.

**Step 4**—Have an adult light the propane torch.

**Step 5**—Place the steel over the flame, letting the light blue cone of heat touch the steel about 2 inches from the tip of the pliers.

**Step 6**—Continue to hold the steel over the flame in the same place. Do not wave the steel bar over the flame. Wait for the iridescent colors to appear.

**Step 7**—When the colors appear, continue to heat the same spot and watch the colors move down the bar. The first that will appear is a faint straw color. Soon others will appear, such as deeper shades of straw, bronze, purple, royal blue, and sky blue.

**Step 8**—When the straw color reaches about  $\frac{1}{16}$  inch from the far end of the steel, quickly plunge the steel into a bucket of water to cool it. This is called quenching. Practice good technique by dunking the steel up and down rather than stirring it.

**Step 9**—When air bubbles and steam stop rising from the metal, wait about 30 seconds, then remove the piece from the water, dry it off, and rub a small amount of lubricating oil on it to protect it from rust.

The colors on the steel will be matched with a corresponding temperature during the tempering step.

## MAKING A CENTER PUNCH

Your first exercise in tempering will be to make a center punch, which is a basic metalworking tool used to put small dents in metal. Unless your counselor suggests another type, use a medium-carbon C1065 steel. The basic technique is the same, regardless of which steel or quenching medium is chosen.

**Step 1**—Measure about 6 inches of C1065 bar steel (either round or square), and mark it with a soapstone pencil.

**Step 2**—Position the cutting line near the edge of the vise. Clamp the jaws tightly to prevent the metal bar from vibrating as it is sawed.

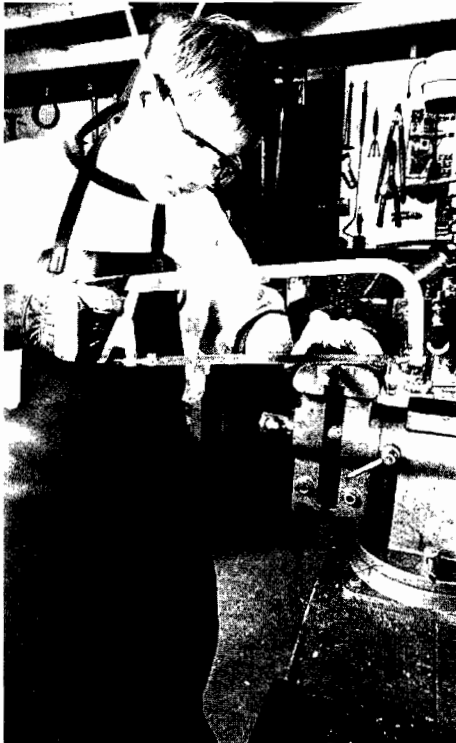

**Step 3**—Using a hacksaw, cut the piece from the bar.

**Step 4**—Set the bar stock aside and clamp the cutoff section in the vise with one end extending about 2 inches.

**Step 5**—Using a flat file, file a short tapered point in one end by bearing down on the forward stroke to scrape the metal. Lift the file away from the metal on the backward stroke. Do not scrub the file back and forth; this dulls the teeth.

## TEMPERING THE CENTER PUNCH

Now you're ready to temper the center punch. For safety, be sure to work under direct adult supervision.

**Step 1**—Using tongs, hold the center punch under a large torch flame or place it in a blacksmith's fire. Bring the metal up to a bright cherry red heat (about 1350 degrees).

**Step 2**—Using tongs, remove the center punch from the heat and plunge it immediately into a nearby bucket of water. Do not throw it into the water. Hold it with the tongs and dunk it up and down in the water. Do not use a swirling motion because that parts the water, preventing it from completely reaching all surfaces of the steel and causing uneven cooling and warping. By moving the hot steel up and down in the water, the gas jacket that forms around it as the water turns to steam is broken up.

**Step 3**—Once the steel is cool, test it for hardness. Do not drop it or tap on it with a hammer, or it will shatter. Run an old file over the steel. (This test will dull a new file's teeth.) The steel will be so hard that it is unscratchable, or glass hard.

**Step 4**—Next, draw the temper. Look at the temper color index chart and decide which temper color to use. Cross-match the colors on the the temper color index with the color descriptions in the temper color index chart to determine the color you will look for when you heat the center punch.

**Step 5**—Using sandpaper, rub the last 3 to 4 inches of the center punch to a bright shine.

**Step 6**—Clamp the striking end of the center punch in a pair of locking-jaw pliers, leaving the pointed end free.

**Step 7**—Light a propane torch and set it in a secure cradle (or let an adult hold it).

## Temper Color Index Chart

Temper Color	Degrees Fahrenheit	Tool Being Made
Greenish blue	630	Light springs
	620	
Light blue	610	Screwdrivers
	600	Wood saws and punches
Dark blue	590	Springs
	580	Picks
Blue	570	Light-work cold chisels
	560	Knives
Dark purple	550	Steel cold chisels
Purple	540	Axes and center punches
Light purple	530	Hammers and sledges
Brown with purple spots	520	Surgical instruments
Dark brown	510	Twist drills
Bronze	500	Rock drills and hot chisels
Dark straw	490	Wood chisels
Golden straw	480	Drifts and leather dies
Straw	470	Penknives
Straw yellow	460	Thread-cutting tools
Yellow	450	Planer tools
Light yellow	440	Drills for stone
	430	Paper cutters and lathe tools
Pale yellow	420	Razors
	410	Burnishers
	400	Scrapers

**Step 8**—Place the shaft of the center punch over the flame, letting the light blue cone of heat touch the steel about 2 inches from the tip of the pliers. Do not wave it over the flame.

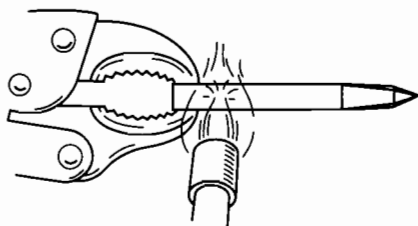

**Step 9**—Wait for the iridescent colors to appear. The first color that will appear is a faint straw color. As the colors move down the bar, shades of straw, bronze, purple, royal blue, and sky blue will appear.

**Step 10**—When the temper color that you have chosen is about  $\frac{1}{16}$  inch from the point of the center punch, quickly plunge the center punch into a bucket of water. Remember to dunk the center punch up and down to break up the steam jacket.

**Step 11**—When the steel has cooled in the bucket of water for a couple of minutes, remove it from the water, dry it off, and then rub a small amount of lubricating oil on it to protect it from rust.

**Note:** If the steel is quenched at the wrong time, the entire tempering process must be repeated. Being able to judge the precise time to quench the steel takes practice.

Many different kinds of tools can be made from the same bar of metal. The variable is the heat at which the metal is tempered. Each tool needs a different final degree of hardness, and that is accomplished by heating it to one of these temperatures, thus relaxing the brittleness just enough to make the tool hard enough to do the job, but not so hard that it will shatter when used.

## Making a Birdseed Scoop

This easy project will give you practice using basic metalworking tools and techniques. First, cut off the factory-made safe edge from the open end of a medium-sized can such as a bean can or a family-sized soup can. Using sheet metal snips, trim the can into a scoop shape. Use a hemmer to bend out a new safe edge. Place the scoop over the pipe anvil and carefully flatten the edge with a mallet. Do not hammer the edge too much, because that will make it sharp.

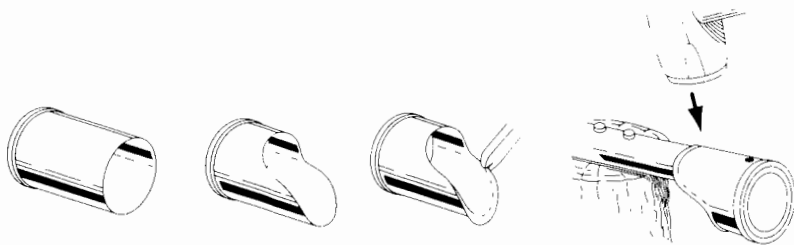

Place a small piece of scrap lumber all the way inside the can to help prevent crushing the can when punching the holes. Using a nail, punch two holes in the back of the can to attach the handle. Be sure the diameter of the nail matches the diameter of the rivets you will use.

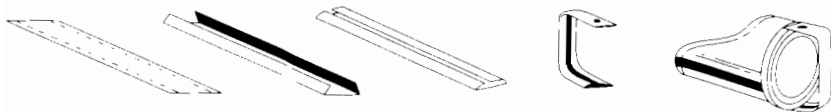

To form the handle, cut apart another can and flatten it. Cut a long rectangle from the metal. Fold over  $\frac{1}{4}$  inch on each edge to make a safe edge. Lay the folded metal handle over a scrap of wood and, using the nail again, punch a hole in each end. Bend the handle strip to match the width of the scoop. Attach the handle with rivets.

More metal can projects



SCOOP

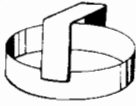

TRAY

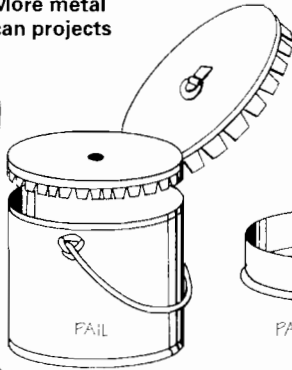

PAIL

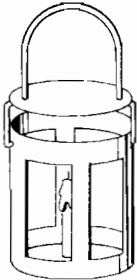
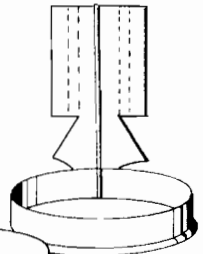

LANTERN

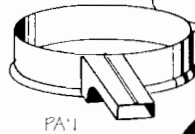

PAIL

CANDLEHOLDER

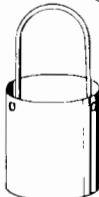

COOKING VESSEL

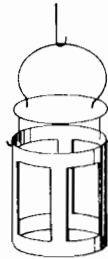

LAMP



TRAY

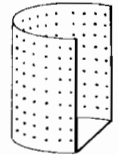

HORSERADISH SCRAPER

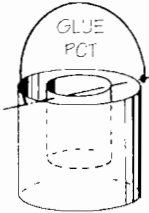

GLUE POT



TOILET PAPER PROTECTOR

FOR WRITING TABLE



SOAP DISH



CANDLEHOLDER



PAN



SUGAR SCOOP

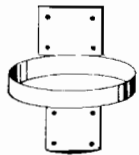

SOAP DISH



LAMP

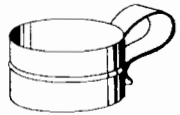

CUP

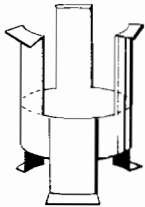

ALCOHOL BURNER OR CANNED HEAT

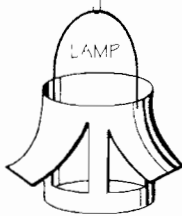

LAMP

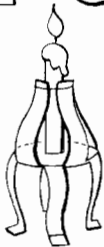

CANDLEHOLDER

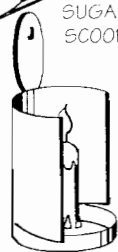

CANDLEHOLDER



STAND FOR HOT POTS, ETC

# The Sheet Metal Mechanic/Tinsmith

## Option 1

The difference between a sheet metal mechanic and a tinsmith is the metal that they use. For the most part, all metalworkers use the same techniques.

Today, people who work with sheet metal are called sheet metal mechanics because they are trained to work with any type of sheet metal. Working with thin sheets of stainless steel, aluminum, mild steel, galvanized steel, copper, and brass, a sheet metal mechanic can make a remarkable range of items.

Using many of the traditional tinsmith's skills along with more modern techniques such as spot welding, sheet metal mechanics make a wide range of components used in things like automobiles, aircraft, satellites, heating and air conditioning systems, building construction, and consumer products. Because maintaining high rates of productivity is so important to manufacturing, sheet metal mechanics use machine tools to assist them when they roll, cut, and bend each item's basic components.

Not all sheet metal mechanics work in manufacturing plants. Many work in local shops that fabricate components for heating and air-conditioning systems. Some make custom-designed components for local building construction firms.

Many of today's tinsmiths are working to preserve the craft. Working with tools of ancient design, they use sheets of tin-plated steel to fashion museum reproductions for collectors and historic reenactors. Sheets of pure tin are rare because pure tin is expensive, but until the 18th century, sheets of pure tin were used to make household objects.



## Basic Sheet Metalworking Tools

The tools needed by the sheet metal mechanic/tinsmith are not much different from the basic metalworking tools you learned about in the previous chapter. However, a few of these tools have special duties in the sheet metal mechanic's shop.

### Anvils

Some of the most basic metalworking tools, *anvils* are the large blocks of iron on which pieces of metal are shaped. There are several types of anvils, and stake anvils are some of the most common.

*Stake anvils* are designed to be moved easily. They are usually mounted in a metal stake holder that has been attached to a stump or a large block of wood. A stake anvil does not need to be as heavy as a blacksmith's anvil because sheet metal is bent rather than forged.

The tinner's anvil has a flat surface with one curved edge. It is used to make straight and curved bends in thin sheets of tin-plated steel. It can be held in the square (hardie) hole of a blacksmith's anvil. The curved sides of the canister stake are useful when turning up the flatlock seam that is used when a capped bottom is attached to a canister or a drinking cup. The widely flared horn of a funnel stake is used to roll tapered cylinders such as a funnel.

The hatchet stake is used for making bends that go past 90 degrees. This is the stake used to put the bends in a flatlock seam. A hatchet stake can be made from a piece of 3/4-inch-thick hardwood, such as maple or ash, that is cut to a 45-degree edge on one side. It can be clamped in a vise and used horizontally or it can be placed on its side on the edge of a worktable with the long side down. Either way it is held, the sheet metal is tapped back against the angled face to form the flatlock seam.

### Hammers

The face of a tinner's hammer is used to set rivets. The tapered end—the peen—is used to coax sheet metal around bits of stiff wire when making a wire edge. The bordering hammer also can be used in more advanced techniques to coax the sheet metal around a wire when making a wired edge and to bend the flatlock seam around the bottom of a canister when making a capped bottom.

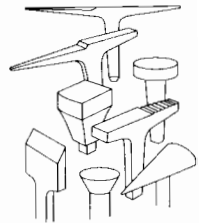

**Stake anvils**

## Hand Shears

Simple hand shears will work for all of the projects described in this pamphlet. Professional sheet metal mechanics and tin-smiths often use large, foot-operated shears or power-operated



shears to cut their pieces from large sheets, but using hand shears is best for learning basic metalworking techniques. Only adults should use power tools.

Make sure to keep hand shears sharp and well-maintained. Never try to cut thick sheets of metal with hand shears—this will dull the cutting edges and can cause the pivot bolt in the jaw to break.

When you're done using the shears, wipe them with a clean cloth to remove the hand oils that cause rust. Be sure to place a light coat of oil on the shears and then wrap them in an oil-soaked cloth to prevent them from rusting. This is a good practice with all steel tools.

## Preserving Your Work

Most finished metal pieces will need to be treated against rust and other forms of oxidation, which will ruin the piece over time. Objects made from zinc-plated (galvanized) metal need no further treatment to prevent rust because the zinc coating is the preservative. Aluminum does oxidize, turning white and chalky. Zinc chromate primer must be applied before painting aluminum or the paint will flake off. Copper, brass, and bronze also oxidize, turning green. Some people like this green effect and encourage the oxidation process by applying salt water to the piece.

Those who prefer a shiny metal surface must apply a degreaser to the metal and then apply a good quality clear-coat sealer. Clear polymer-based varnishes are often used. Tin-plated steel need not be painted because the tin coating acts as the preservative. Because the tin coating is so thin, it must be washed and dried after handling to remove natural salts and acids left by human hands.

## Sheet Metal Projects

The sheet metal projects described in this pamphlet create simple objects that can be useful in camp. If you have an idea for a project that isn't described here, you may design your own. Be sure your design uses some of the basic metalworking techniques described earlier.

Regardless of whether you have decided to make practical objects or art objects, be sure to show your design sketches to your counselor and to obtain your counselor's permission before you begin working on your projects.

### Basic Tools Needed

- Bick iron stake
- Hatchet stake (can also be made of hardwood with one edge cut to a 45-degree bevel)
- Funnel or canister stake (optional)
- Stake holder
- Short length of 3-inch-diameter iron pipe
- Mallets
- Sturdy machinist's vise
- Sheet metal shears
- 1-inch hole punch
- Stump (for mounting the stake holder)
- 125-watt or 150-watt soldering iron
- C-clamps
- 2-by-4-inch wood pieces in various lengths
- Center punch
- Steel ruler
- Hemmer
- Hand seamer
- Scriber
- Steel dividers
- Try square
- Needle-nose, lineman's, and locking-grip pliers
- Various patterns
- Flux brushes
- Shop apron
- Leather gloves
- Safety glasses

## Materials

- 26-gauge or 28-gauge sheet metal
- Lead-free solder
- Soldering flux
- Wire coat hanger
- Finishing nail (to prick pierced patterns in sheet metal)
- 1/4-inch copper tubing
- Three 4-by-6-inch pieces of window glass (1/4 inch thick) per lantern

### 16-ounce metal cup

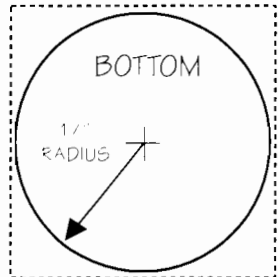
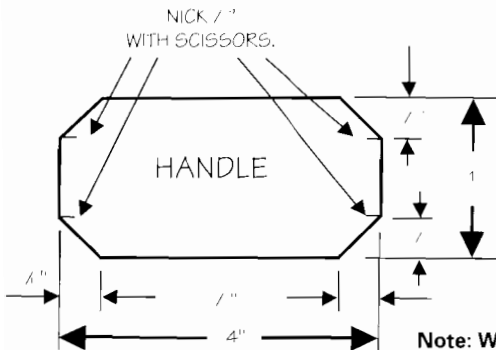
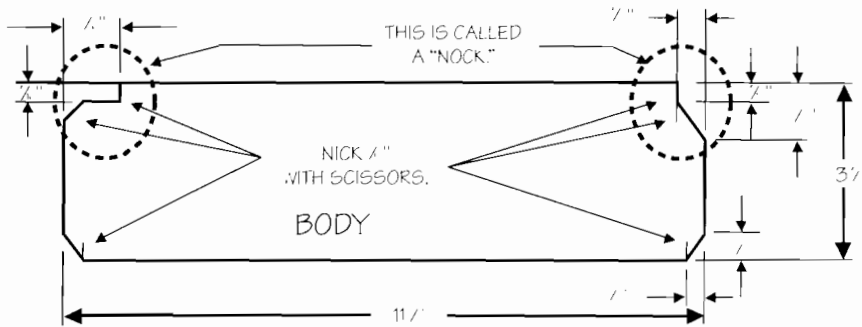

**Note:** When folding, align both of the nicks with the edge of the bending block. Start the bend by tapping the metal over the edge of the block with a mallet.

## Making a 16-Ounce Metal Cup

**Step 1**—Make patterns by drawing the shape of each piece on stiff paper and then cutting them out. Use these patterns to scribe the outlines onto the sheet metal with a sharp nail or a metal scriber.

**Step 2**—Using sheet metal shears, follow the scribed lines to cut all three pieces from the sheet metal. Use construction scissors to snip the  $\frac{1}{16}$ -inch nicks in the pieces to be used as the cup's body and handle. Do not place nicks in the pattern.

**Step 3**—Place the nicked sheet on a sharp-edged board. Align each fold's nicks with the edge of the board and use a mallet to tap the folds over.

**Step 4**—The two nicks are cut to accommodate the cylinder's flatlock seam and the single hem that is used to make a safe edge on the top of the cup. Make all the folds in the body and handle before soldering anything together.

**Step 5**—Roll the body into a cylinder by bending it around the end of a short section of 3-inch iron pipe. If necessary, remove the cylinder from the pipe to clip the flatlock seam together.

**Step 6**—After clipping the seam together, wrap the steel pipe with a cloth to prevent scratching the inside of the cup. Slide the cylinder back onto the pipe and lock down the seam by flattening it with a mallet.

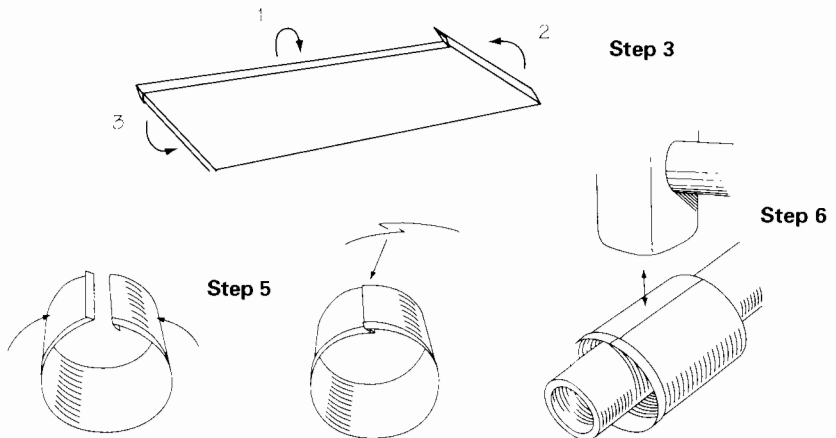

**Step 7**—Flux the flatlock seam and solder the body of the cup together using lead-free solder and an electric soldering iron. If the cylinder still isn't round, slip the soldered cylinder over the pipe and gently shape it by tapping it with a mallet.

**Step 8**—Cut a disk for the bottom. Either leave the bottom flat or roll the edge of the bottom disk.

**Step 9**—Flux the bottom of the cylinder and temporarily attach the bottom to the cylinder by soldering it in four places. Once the bottom is in place, run a continuous line of solder around it to make a watertight seal.

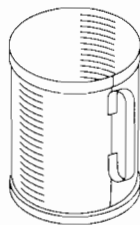
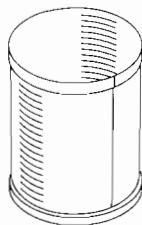
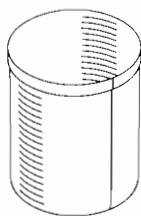

**Step 10**—Solder down the safe edge along the top of the cup. This prevents the bent part of the edge from cutting your lip when you drink.

**Step 11**—Fold about  $\frac{1}{4}$  inch of the handle, both top and bottom, making a C shape. Use a pair of pliers to put a slight curve in each tab to match the contour of the cup. Solder these tabs to the cylinder, attaching the handle to the cup.

## Making a Lantern

**Step 1**—Arrange the patterns on a piece of sheet metal and scribe the outlines onto the sheet metal with a sharp nail or a metal scribe. Cut out each component using sheet metal shears and file all edges smooth.

**Step 2**—Punch a large hole in the center of the parts marked “cut out” in the pattern diagram; these parts will become the windows. Stick the tip of the snips into the hole and carefully cut a curved line until you reach one of the scribed lines that outline the shape of the window. Now you can cut straight along the scribed line.

**Step 3**—Fold the lantern body’s  $\frac{1}{4}$ -inch bends first, making sure to fold them in opposite directions. Next make the four body folds.

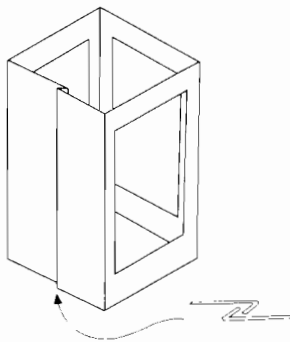

**Step 4**—Fold a hem on the candleholder and flatten it slightly with a mallet. Roll the candleholder into a cylinder around a  $\frac{1}{2}$ -inch dowel. Don't try to close the gap in the cylinder—it comes in handy when removing melted candle stubs. You can use the blade of a screwdriver to pry out the melted wax.

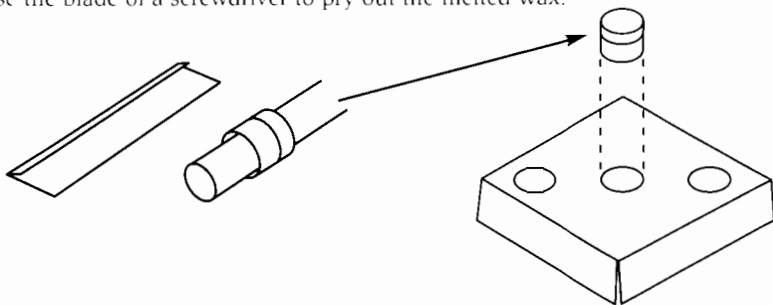

Patterns for the lantern project.

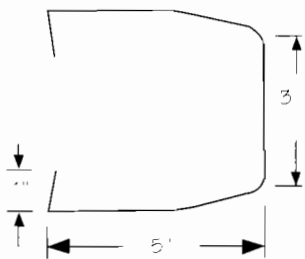
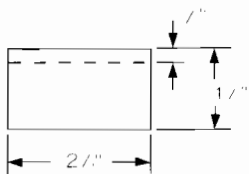
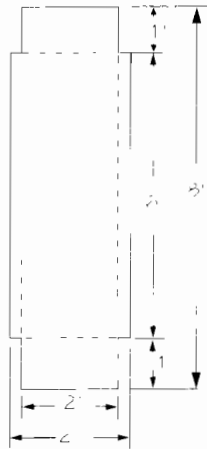
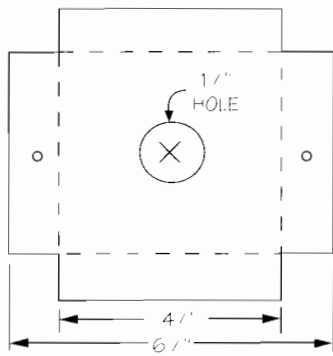
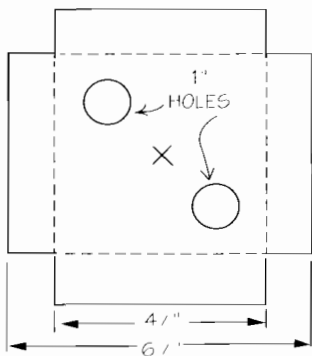
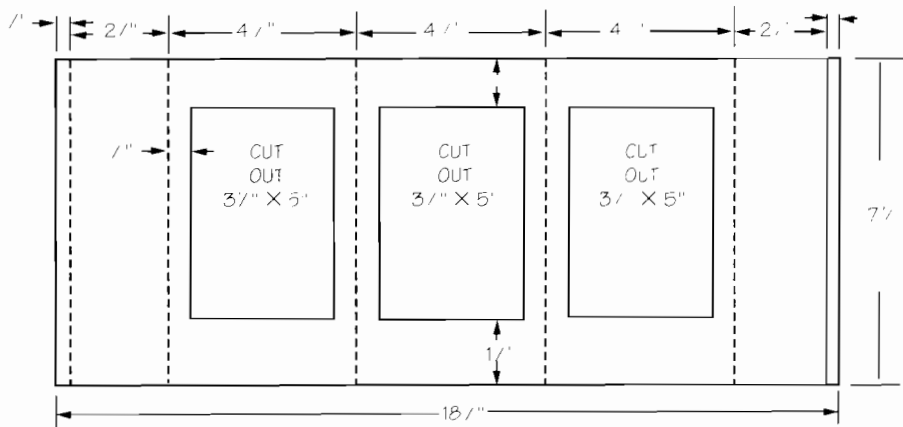

GLASS SIZE  
X 4 X 6  
3 REQUIRED



**Step 5**—Create the bottom piece by punching two large air holes in the base as shown and then folding down all four sides. Don't worry about leaving a small gap between each fold because this piece fits inside the body of the lantern. Solder the candleholder in place.

**Step 6**—Fold both  $\frac{1}{4}$ -inch hems on the heat shield component. Fold the tabs as shown. Roll the heat shield into a flat-topped arc.

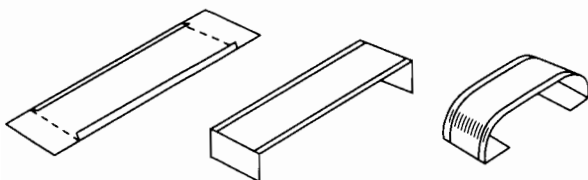

**Step 7**—Create the top piece by punching a large air hole in the center of the piece. Punch two small holes in an opposite pair of tabs for the wire handle. Fold down the sides—don't worry about leaving a small gap because this piece fits over the lantern body. Solder the heat shield into place.

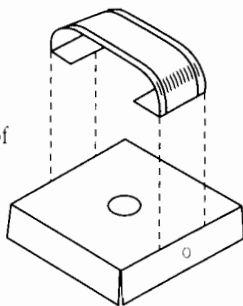

**Step 8**—Set the body of the lantern over the bottom piece and solder the bottom in place.

**Step 9**—Make the glass holders by cutting pieces of  $\frac{1}{4}$ -inch copper tubing to fit inside the lantern. Cut two lengths of tubing for each corner. Use florist's wire to wire them together in pairs, then solder them together. Remove the wires.

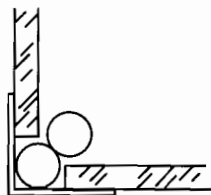
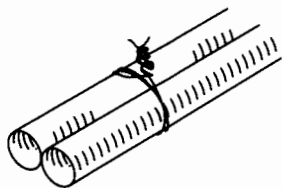

**Step 10**—Use a wire coat hanger to make the handle. Cut off the hook and straighten the length of wire, then bend it into the shape of a handle.

**Step 11**—Set the top on the body (it fits on the outside). Poke the scribe through the holes in the top and mark the corresponding spot on the body.

**Step 12**—Remove the top piece and use a nail to punch holes where you just marked.

**Step 13**—Have an adult cut three 4-by-6-inch pieces of  $\frac{1}{8}$ -inch window glass. Put them in the lantern body and hold them in place using the copper glass holders.

**Step 14**—Place a candle in the lantern and attach the top using the wire handle.

**Note:** To replace the candle, unhook the wire handle and remove the top piece.

# The Silversmith

## Option 2

Silversmiths do much more than hammer silver into beautiful shapes. They are artists who design one-of-a-kind pieces that start as a sheet of silver, often incorporating elegant hand engraving and beautiful patterns. They are also highly skilled in a number of metalworking techniques.

Well-trained silversmiths know how to function as sheet metal mechanics. They cut, bend, edge, roll, file, saw, rivet, solder, and braze, using sheets of silver, copper, nickel silver, and pewter. Silversmiths are pattern makers and founders. They carve their own intricate patterns, create the molds, melt the silver, and then pour it into the molds. Silversmiths know the craft of the blacksmith. They know how to forge and temper high-carbon steel to make their own engraving tools, chasing tools, hammers, and stake anvils.

Like the other metalworkers, silversmiths are practical metallurgists who understand the properties of the metals they use. They know when to anneal a work-hardened piece and how to use work hardening to their advantage.

### Basic Silversmithing Tools

Silversmiths use many of the same tools as other craftsmen, but because the objects silversmiths create are smaller, their tools are scaled accordingly.

#### Hammers

The hammers used by silversmiths have specific shapes that have been refined over thousands of years to perform specific purposes. Each hammer's face has a slightly different curve.

Raising hammers and forming hammers are used for making curved shapes. A planishing hammer is used to remove



**Raising Hammer**

---

Hammers and stakes have smooth, highly polished surfaces.

Great care must be taken not to mar the surfaces of these tools since any defect will transfer to the silver as you hammer it. Rub the tools on a piece of cloth to burnish them before use and clean them immediately after use, giving them a coating of oil to preserve them from rust.

---

dents made by other hammers during the raising and forming stages. Forging hammers are used to fashion an object from thick material. Because forks, spoons, and ladles, for example, are often made from heavy-gauge metal, forging them requires a much heavier hammer. Forging hammers usually weigh 18 to 24 ounces.

***Planishing*** is the process of smoothing the finished piece, so hammers used in this process must be fairly specialized to do the job. Some planishing hammers have both a round face and a square face. The square face is helpful for working with the corners of rectangular pieces. One of the final steps in silversmithing, planishing work hardens the metal while giving its surface a much more uniform appearance.

After each use, wipe the hammer's steel faces with a clean, lubricated cloth and wrap its head in an oil-soaked cloth for storage. This is especially important if the hammer will go unused for an extended period of time.

### **Mallets**

Like the other metalworkers, silversmiths use mallets to bend sheet silver. Made of rawhide, hardwood, plastic, or nylon, these soft-faced mallets are less likely to mar the surface of the metal than a metal hammer. Some silversmiths glue leather to the faces of their wooden raising mallets to cushion blows even more. Mallets are used to true up, or straighten, pieces that have become warped or bent during sinking or raising steps.

### **Stakes and Anvils**

Silversmiths use some of the same *stakes* and *anvils* as sheet metal mechanics and tinsmiths, such as the bottom stake and the ball stake. Some stakes silversmiths use look the same as other craftsmen's tools but are much smaller in scale. In other cases, some of the silversmith's stake anvils are uniquely different.

The raising stake is an example of a stake that is uniquely the silversmith's. Used with a raising hammer (a hammer with a head that has a similar curve to the desired curve), the raising stake is used to curve flat sheets of metal. Water pitchers,

bowls, and flower vases, for example, start off as flat disks of silver, and the raising stake or hammer lifts—or raises—the metal to form the shape.

## Sawing Equipment

Silversmiths consider both saw blades and files to be sawing equipment. One of the most basic skills of a silversmith or jeweler, sawing is used to cut openings in decorative shapes along the edges of objects. The equipment needed for sawing is minimal: a saw frame, a saw blade, a *bench pin* to hold the metal still during sawing, and a C-clamp to hold the bench pin to the workbench.

While saws are used for cutting larger pieces, small files are used to refine the shape of silversmiths' designs. Small, straight files called needle files are commonly used, and curved files called riffer files come in handy for specialty pieces.

## Pickling Solution

Silversmiths use an acid bath called *pickling solution* to remove residue left after soldering and oxidation caused by heating during the annealing process. A solution of 10 percent sulfuric acid and 90 percent water is often used. Commercial pickling products are available in a granular form to be mixed with water as needed.

**Never use a steel item to reach into the pickling solution. If you do, everything in the solution will become copper-plated. This is because the pickling solution removes some of the copper found in sterling silver. Once the steel item is removed, the solution will be fine again, but the plated objects must be polished heavily to remove the copper layer. To remove items from the solution, always use sticks or tongs made of wood or copper. Rinse the pickled object in fresh water and dry it completely. Also, never leave soldered work in the solution for more than a couple of hours—it will weaken solder joints.**

---

Be sure to purchase the proper saw blades for the project. Saw blades can be inexpensive, but cheap, flimsy blades are no bargain. At the least, buy blades of good enough quality to avoid frustration. Match the thickness of the blade to the thickness of the piece being cut. *Make sure that at least three teeth touch the metal at all times.*

---

## Basic Silversmithing Skills

While they know the basic techniques of metalworking, silversmiths must know some techniques that are specialized for the types of materials and tools they use.

### Laying Out Lines

One old saying, “Measure twice, cut once,” is good advice when it comes to laying out lines. When using dividers, loosen the setscrew and place the tips against a steel rule. Holding one tip firmly at the zero point, spread the dividers until the second tip has reached the desired measurement. Lock the setscrew in place to hold the legs securely and use the tips to mark off the line.

**Use a square to establish a 90-degree corner, checking from both sides to be certain the angle is correct.**

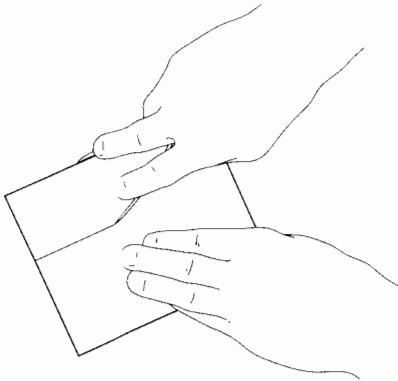
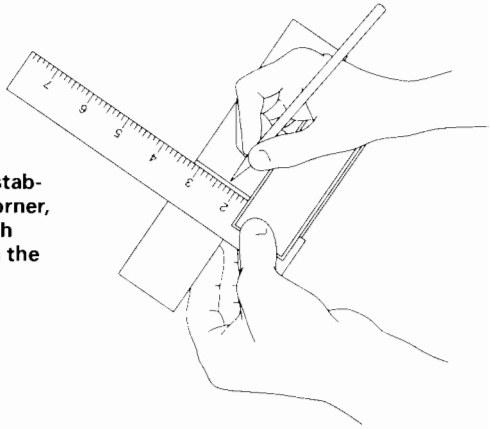

**To lay out a strip with parallel sides, drag one leg of a divider along a prepared edge. Scrub the metal with a scrub sponge in a circular motion so the scratch line shows clearly.**

## Sawing

While sawing might seem to be a fairly basic and easy skill to master, care must be taken when it is used as a metalworking technique. The jeweler's saw is a common sawing tool used by silversmiths, and it must be handled with care to prevent injury and ensure proper use.

To use the jeweler's saw:

**Step 1**—Make sure the blade is firmly attached to the saw frame, with the teeth pointing toward the handle.

**Step 2**—Hold the saw so the blade is perpendicular to the work. Reach under the bench pin to do this properly. Take care not to jab at the metal.

**Step 3**—When preparing to saw, relax your grip. Let the saw blade do the work.

**Step 4**—Use long, relaxed strokes to saw. Periodically touch a piece of beeswax or candle wax to the blade as a lubricant.

**Step 5**—Turn the work while sawing. Be careful not to turn the saw.



## Sinking

To a silversmith, sinking means to hammer a depression into a piece of flat metal. This technique, which stretches the metal, is used to make bowls, plates, and serving trays. Most objects that use the sinking technique consist of three parts:

- The rim—the flat part used to pick it up
- The bouge—the curved sides of the depression
- The platewell—the horizontal bottom of the piece into which the bouge transitions

Sinking very shallow forms can be accomplished by using a sandbag and a hammer, but it takes considerable time to achieve the desired depth. Because the sand shifts under each blow, the metal doesn't move a great deal.

Using a *sinking block* yields faster results. Hammering the metal over a depression carved into a block of hardwood such as beech or maple allows for greater stretching with each blow, with the sides of the wooden block supporting the metal as it is stretched to the desired depth and shape.

However, the final form should not conform to the depression. That is, don't hammer the metal until it is driven to the bottom of the depression (called "bottoming out")—this ruins both the surface of the sinking block and the work. Bottoming out puts dents in both items because the metal can no longer yield in two directions as it could when it was suspended over the curved depression. When the hammer squeezes the metal between itself and the block, the metal will push out to the side around the hammerhead, forming a dent.

One way to create a sinking block is to cut a hole in a thick piece of hardboard or plywood. Drive roofing nails along the edges and attach the metal to the board by holding the work in place with the nail heads. Using a silversmith's hammer with a

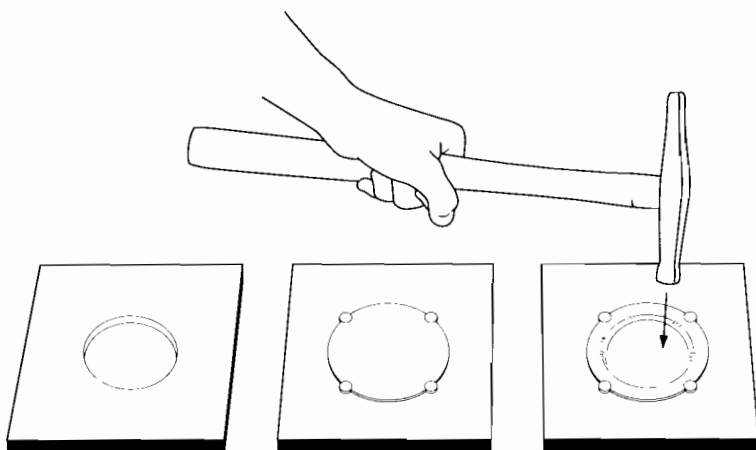

head that has a radius that matches the desired curve of the bouge, tap the metal along the inside perimeter of the hole, driving the material into the gap between the surface of the workbench and the top of the board. Work the metal until it almost touches the bottom surface—remember that you are stretching the metal when you are using the sinking technique.



The bowl of the tray or plate cannot be created with only one sinking step. Trying to do so will stretch the metal so much that it will tear, so several sinkings will be necessary. Be sure to anneal the object between each sinking and remove the nails after the first sinking.

## **Soldering**

Soldering is a basic skill used often by silversmiths. As with most skills, practice at soldering will help you achieve better results.

### **SWEAT SOLDERING**

At times you may wish to apply a special piece to the surface of another. Perhaps you have fashioned a small fleur-de-lis that you would like to attach to a flat disk that will become the front of a neckerchief slide. To attach that fleur-de-lis without obvious signs of soldering, use the *sweat soldering* technique.

**Step 1**—Turn the fleur-de-lis on its back and melt on a couple of small pieces of silver solder. Do not let them flow away, just heat them until they have attached themselves—they should still be small blobs of silver solder at this point. Set the piece aside.

**Step 2**—Place a small amount of flux on the disk where you want to attach the fleur-de-lis.

**Step 3**—Carefully position the back of the fleur-de-lis onto the flat disk. Play the torch flame over the fleur-de-lis until the silver solder flows. Be careful not to let the silver solder flow out from under the fleur-de-lis. The attachment should look as if you carved it in place.

## **Preserving Your Work**

Silver, copper, and brass must be polished regularly to prevent oxidation from dulling and pitting the finish. Use a good grade of metal polish and take your time during polishing. Apply a liberal amount of polish to a lint-free cotton cloth. Working on small sections and using a circular motion, rub the pumice into the metal until it is polished to a high luster.

## Silversmithing Projects

Listed below are the basic tools and materials needed to make the projects shown in this pamphlet. You don't have to buy specialty tools from catalogs; many of these tools can be made from things found in scrapyards.

### Basic Tools Needed

- Raising hammer
- Planishing hammer
- 16-ounce forging hammer
- Flat-faced wooden mallet
- Peen-ended wooden mallet
- Raising stake
- Bottom stake (optional)
- Ball stake
- Stake holder (optional)
- Stump (used to mount the stake holder)
- Flat files
- Riffler files
- Jeweler's saw
- Jeweler's saw blades
- Bench pin
- Sturdy wooden bench
- Sheet metal snips
- Try square
- Metal straightedge
- Ruler
- Scriber
- Steel dividers
- Center punch
- Silver solder (at least three types, of different melting temperatures)
- Flux (borax paste)
- Brazing station (several hearth bricks or pea gravel in a heavy pan; avoid using aquarium gravel coated with epoxy)
- Pin-flame propane torch
- Bouge (your choice of hole diameter)
- 10-gallon or larger pickling tank with close-fitting lid

## Materials

- 10 percent sulfuric acid solution
- Sheet copper of varying gauges
- 1/8-inch hardboard
- Cotton shop cloth
- Crocus cloth
- Machine oil
- Wooden tongs
- Jeweler's pumice of various grits
- Cotton cloth
- Silver polish (or type of polish appropriate to the metal being used)

## Forging a Spoon

This is a project that is hammered cold. Use 18-gauge or 20-gauge sheet copper instead of sheet silver. Copper has the same properties as silver and is less expensive. As you forge the bowl of the spoon you may find that you need to soften it. Remember that nonferrous metals are annealed by heating them to a red heat and then quenching them in water. To meet the requirement for a soldered joint, you may wish to fashion a small Boy Scout fleur-de-lis and apply it to the handle of the spoon by using the sweat soldering technique.

**Step 1**—Draw the pattern onto the metal using a marking pen. Be sure to mark out the dotted line—this gives you sufficient material to make a fairly deep bowl.

**Step 2**—Using a jeweler's saw and a bench pin, saw out the basic shape of the spoon.

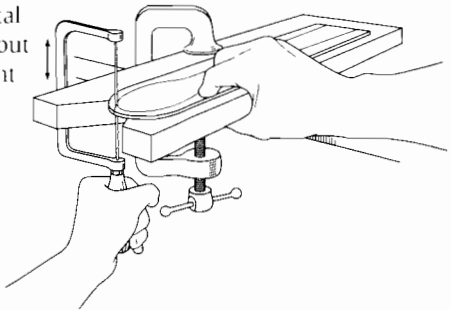

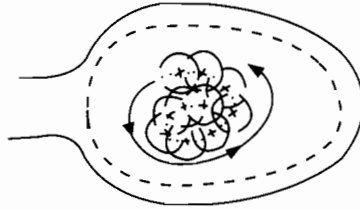

**Step 3**—Using a forging hammer to thin the metal in the bowl of the spoon, strike a series of blows beginning in the center of the bowl and working out to the edge as shown.

**Step 4**—Using a bouge and a curve-faced hammer, sink the spoon's bowl. Place the bowl of the spoon over the cavity and stretch the bowl using a silversmith's hammer that has a radius that corresponds to the radius of the bouge. Remember to stop hammering before the metal touches the bottom of the bouge to help prevent denting the bouge and ruining it. If the edge of the bowl warps, place it upside down on the anvil and tap it back into line with a wooden mallet. Anneal after each sinking.

**Step 5**—Once the bowl has been drawn out to the proper width and thickness, forge the spoon handle. Working along the spine of the handle, strike from the center outward. Flair the end of the handle and keep it narrow near the bowl. Use a kitchen spoon as a guide. Anneal as often as necessary.

**Step 6**—File the edges of the spoon smooth. Be careful not to scrub the file back and forth. Push the file away from you to remove metal, and lift it up on the return stroke. This keeps the file's teeth sharper longer.

**Step 7**—Soak the finished spoon in the pickle bath for about 20 minutes to remove oxides and fire scale. Use wooden tongs to retrieve it from the pickling tank to avoid accidentally staining the piece. Flush the piece with plenty of water to neutralize the remaining acid, then dry it with a clean cloth.

**Step 8**—Polish your work. Remove the swirls and manufacturing marks by rubbing the piece with pumice. Start with a coarse grit and gradually move to finer and finer grits as the desired degree of shine appears.

# The Founder

## Option 3

A person who pours molten metal into molds is called a founder. Ancient humans began melting metal and pouring it into molds almost as soon as they discovered how to hammer it into shape.

Numerous industrial companies cast metal, and most city telephone books will contain a listing for at least one *foundry*. Not all foundries are huge factories employing scores of people. While those certainly do exist in the United States, some foundries can be quite small. Some of the smaller foundries specialize in producing hard-to-cast shapes using hard-to-cast metals.

Some smaller foundries cater to artists whose sculptures will become patterns for limited-edition castings. In some cases the artists operate their own foundries and make their own castings. Increasingly, hobbyists are casting metal on a small scale in their garages and workshops.



---

If you wish to whittle your pattern rather than sculpt it, use a softer hardwood such as basswood or tupelo, or use carvable sculptor's wax, which can be reused.

---

## Basic Tools and Skills

Founders use skills and techniques that are different from other metal workers. Their craft includes making and working with molds to create pieces from molten metal. While some founders use premade molds to cast the metal shapes, many founders are involved in every step of the creation process, including carving or sculpting their own patterns to shape the molds.

Keep in mind that working with molten metal is dangerous. Always have adult supervision when working with any of these techniques.

### Making a Pattern

The pattern must be created before the mold can be made. The first step is to draw a full-size sketch of the object. This two-dimensional drawing will have to translate into a three-dimensional object, so limit the depth of the object to about  $\frac{1}{2}$  inch.

Sketch the pattern with the finished piece in mind. Pieces designed with projecting elements such as extended arms or legs modeled in running poses cannot be cast in one piece because the arm or leg will stick in the mold and prevent the piece from being released. Keep the design simple and within your capabilities to create a model.

**Designs with slightly beveled sides (called "draft") rather than perfectly straight sides are more easily removed from the mold. Only three or four degrees of draft are necessary, so you can still give the illusion of perfectly straight sides. Avoid undercuts (sometimes called "ledges") that will jam in the mold, making it impossible to remove the finished piece.**

The next step in pattern making is to sculpt the model using sulfur-free polymer clay. Use a variety of tools to creatively carve the details of the piece. Follow the clay manufacturer's instructions to bake the model until it is hard.

## Making a Mold

When the pattern is complete, it can be used to make a mold, which will hold the molten metal until it is hard. Mold makers can choose from at least four different types of molds for casting metal:

- Lost-wax mold, in which the wax pattern is eventually burned out of the mold, forming a highly detailed cavity
- Rammed-sand mold, which is made by compressing a box of fine-grained sand around a pattern
- Metal molds, which became popular during the industrial revolution and are the most expensive type of mold
- Rubber molds, which are durable and reusable molds most often made from *room-temperature vulcanizing (RTV) silicone rubber*

No matter which mold-making method is chosen, remember to include vents and a *sprue*—the opening in the mold through which the molten metal will be poured.

## Casting Molten Metal

In metal *casting*, the metal is heated to its melting point and poured into a clean mold. Using an electric melting pot with a thermostat and a bottom-pour spout will help control the temperature of the metal and help prevent impurities from entering the mold when the molten metal is poured.

Mold lubricants, such as finely powdered graphite, help the molten metal flow into the mold and prevent the metal from sticking to the mold when it is being removed. The lubricant should be smeared into a fine coating that thoroughly covers the piece like grease. Use a stiff-bristled brush to work the lubricant into the crevices of the mold.

**For your health and safety, use lead-free pewter. Lead ingots leave lead particles on the skin and can get into your food and your body. Molten lead produces dangerous fumes. Lead poisoning causes brain damage. Using lead-free pewter will prevent all these problems.**

---

The process of applying lubricants to a mold is called *blackening*, because early silversmiths would hold their molds over a candle flame, letting the soot coat the mold.

---

A metal mold should be preheated by making two trial runs before the final cast is poured. This is another secret to making high-quality castings. The castings made with the trial runs will be flawed, but mistakes can be melted down for another try. Save these pieces for later, because adding them to the pot will add wait time while the metal completely melts again.

**Always place the mold as close to the melting pot as possible. Some melting pots allow the mold to be filled directly from the bottom of the pot to prevent the dross—impurities that float to the surface of molten metal—from being poured. If a transfer ladle is used to fill the mold, the dross must be skimmed off before the mold is filled. Once the transfer ladle is full of molten metal, move quickly to minimize heat loss. Pour the molten metal at a rapid and steady rate.**

The piece should be allowed to cool completely before disassembling the mold and removing the piece from it. Any scars in the metal left as evidence of gates, vents, and parting line flash can be filed and polished until they are no longer detectable.

### **Preserving Your Work**

Pewter does not need to be covered with a finish to preserve it from oxidation. However, some people like to paint their cast metal figures. If you do so, paint the piece with a metal primer before applying color. White primer works best since white makes a better color base for the finished colors. If you can't find white primer, use gray metal primer, but cover the figure with a thin base coat of white paint before applying the colors. Always apply thin coats of paint so that you do not obscure the figure's details and so that the paint does not sag and drool.



## Casting Projects

Use the following checklist to gather the tools and materials necessary to complete the founder option requirements for this merit badge.

### Basic Tools Needed

For creating the RTV silicone mold:

- Four spring clamps
- Two disposable paint brushes (one for the applying the RTV silicone and one for applying the graphite to the mold)
- Disposable rubber gloves

For creating the pattern:

- Sculpting tools
- Hobby knife
- Toaster oven

For casting the molten metal:

- Electric melting pot with thermostat
- Heavy aluminum baking tray for use as a pouring station
- At least one premade metal or silicone rubber mold
- Scout-made silicone rubber mold
- Riffler, needle, or jeweler's files
- Standard screwdriver
- Spring clamps
- Hobby knife
- Shop apron
- Insulated leather gloves
- Safety glasses

## Materials

For creating the pattern and mold:

- 12 panels of thin plywood or hardboard cut into 4-by-6-inch rectangles
- Four small wooden pegs, each about an inch long
- One pound of sulfur-free polymer modeling clay
- Plastic wrap or aluminum foil
- Approximately 16 ounces of two-part RTV silicone rubber for one figure that is 2 ½ inches tall by 1 inch wide by ½ inch deep
- Four disposable mixing cups. Two of the cups must be large enough to hold the contents of each rubber pour.
- Two disposable mixing sticks
- Approximately 1 ounce of mold release cream (petroleum jelly is effective)

For casting the molten metal:

- A Scout-made pattern
- An instructor-provided mold
- Fine graphite powder
- Lead-free pewter (approximately 2 ounces per each 54-millimeter figure)
- Tempered hardboard, ¼-inch thick, cut in pairs to the size of each rubber mold
- Soap and water to clean graphite from hands
- Paper towels

## Preparations

- Collect all materials before starting.
- Choose a well-ventilated spot.
- Determine where to place the sprue and vents on the pattern.
- Make the sprue and vents from wax, wood, or sulfur-free clay before mixing the RTV silicone rubber.
- Make locator pins before mixing the RTV silicone rubber.
- Measure the pattern against the stock of box-making panels and select those large enough for the necessary clearance.

## Making a Silicone Rubber Mold

**Step 1**—Study the pattern and decide where the *parting line* should be and where to place the sprue and vents. When deciding where to place the sprue, choose a location such as the bottom of the piece where no one will see where the sprue is attached. In this example, the sprue will be attached to the bottom of the truck-shaped pattern. Use some of the polymer clay to make a cone-shaped sprue and one or more vents.



**The dotted lines drawn on the pattern above indicate where the parting line will be.**

**Step 2**—Make a molding flask out of pieces of plywood or hardboard. Use some of the sulfur-free clay to hold the pieces together. As the box is built, place the pattern in it and check it for fit. Make sure there is a minimum clearance of  $\frac{1}{2}$  inch all around the model. If the pattern will be embedded in a layer of clay, estimate how thick the clay will be. Holding the pattern in the box to simulate for the clay layer, check for at least  $\frac{1}{2}$ -inch clearance from the top of the embedded pattern to the top of the box.



**Step 3**—If the flask is made of loose panels, make sure that there is a good seal with the polymer clay to prevent the RTV silicone rubber from leaking. Wrap a rubber band around the panels to hold them together.

**Step 4**—Spread a layer of polymer clay in the bottom of the flask. Make it deep enough to prevent any part of the pattern from touching the bottom of the box as it is pushed into the clay down to the parting line in step 6.

**Step 5**—Wrap the portion of the pattern that is to be embedded in clay with aluminum foil or plastic wrap. This will prevent it from picking up any clay residue that will obscure the details when making the second half of the two-piece mold.

**Step 6**—Embed the wrapped half of the pattern up to the established parting line. Make sure that no part of the pattern touches the bottom board.

**Step 7**—Insert the two alignment pegs into the clay. Putting the pegs in opposite corners (about  $\frac{1}{4}$  inch from the corner) will locate the two halves correctly. Attach the pouring gate and vents to the model.

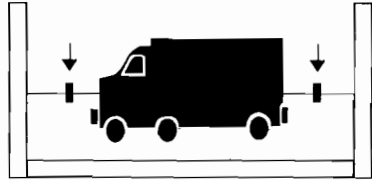

**Step 8**—Using disposable mixing sticks, prepare the RTV silicone rubber according to the manufacturer's instructions. Be sure to wear rubber gloves when working with the liquid silicone rubber mixture.

**Step 9**—Brush a thin layer of mixed RTV silicone rubber over the pattern. This will discourage the formation of air bubbles in the small crevices.

**Step 10**—Holding the container as close as possible to the flask, slowly pour the mixture over the pattern, allowing it to fill all the crevices and to level off. Continue pouring until the top of the RTV silicone rubber is a minimum of  $\frac{1}{2}$  inch above the highest point of the model. Lift an edge of the tile about a half inch and let it fall quickly, lightly rapping the piece on the table a few times to drive the bubbles to the surface.

**Step 11**—Place the top board on the flask.

**Step 12**—*Cure*—allow the chemical reaction progress to happen—by letting the piece rest until the RTV silicone rubber has hardened to its maximum amount—for eight hours at room temperature.

**Step 13**—Invert the flask and disassemble it. Remove the clay, the foil or plastic wrap, and the alignment pegs.

**Step 14**—Reassemble the flask and attach the pouring sprue and vents. Use clay to hold the flask together.

**Step 15**—Apply mold release cream to all of the exposed areas of the cured silicone rubber. The silicone rubber only sticks to itself.

**Step 16**—Repeat steps 8 through 12 to create the second half of the mold.

**Step 17**—Disassemble the box and separate both parts of the mold from the original. Remove the pattern.

**Step 18**—Check the sprue and the vents to make sure they are not constricted. If they are, use a hobby knife to cut the RTV silicone rubber. The molten metal will be poured into the mold cavity through the sprue, and the air will escape through the vents.

**Step 19**—Reunite the two halves of the mold, making sure that the silicone alignment pins drop into the holes. Place a piece of thin plywood or a tempered hardboard panel on the front and back of the mold to reinforce the rubber. Use two spring clamps and press two panels together opposite the sprue. This will help prevent the molten metal from leaking out.

## Tips for Casting Lead-Free Pewter

Lead-free pewter is composed of 91 percent tin. The remaining percentage is made up of copper, antimony, and bismuth. Metals with high tin content have excellent flow characteristics and work well with highly detailed figures. Pure tin is the best material for pouring figures, and figures made from pure tin can easily bend without breaking. Following these tips will yield the best results:

- Tin fumes are toxic, so be sure to do your melting and pouring in a place that has plenty of ventilation, and keep your head away from the melting pot.
- Heat the metal to between 550 and 650 degrees. Use a thermometer to obtain the correct temperature. Use the lowest temperature you can that produces good castings.
- Wait at least fifteen minutes after the metal has melted before pouring the mold.

## Using a Silicone Rubber Mold

**Step 1**—Use graphite powder to lubricate the rubber mold. This will help prevent the cast metal from sticking to the rubber and will help the molten metal to flow freely through the smaller parts of the mold. With an applicator brush, dust a small amount of finely powdered graphite over the mold and then smear the graphite into a greasy coating with your fingertips. Clap the molds together to remove any excess powder.

**Step 2**—Position the tempered hardboard mold supports on the outside of each mold half. The mold should be clamped in at least two positions with spring clamps for best results.

**Step 3**—Heat the lead-free pewter to between 550 and 650 degrees. Use the coolest temperature that you can to obtain good quality castings. Experiment with the melting pot's heat settings to discover where the coolest temperature is. Use a thermometer to discover the best temperature for use with your particular molds, and write that temperature on the mold with a permanent marker for future reference.

**Step 4**—Pour the metal quickly into the mold, filling it to the top. If the mold fills too slowly, widen the throat of the sprue a little bit. A slow-filling mold will let the metal solidify prematurely, preventing the figure's extremities such as hands and hand-held objects from filling with metal. Use a sharp hobby knife, a small file, or a rotary burr to remove a small amount of the rubber from both halves of the mold.

**Step 5**—Using gloved hands, squeeze the sides of the mold together after pouring. Tap the mold gently on the work surface at the same time to help improve the detail and reduce the *flashing* (the small amount of metal that leaks around the parting line) around the figure. Always wear insulated leather gloves when pouring and holding the mold. Allow the mold to set for at least one minute before opening it. When the figure is being released from the mold, the mold can be bent slightly, if necessary.

Properly handled, the rubber molds will give you long and continuous use. Allow rubber molds to cool after each use. Because rubber is not as good a conductor of heat as is metal, the rubber molds retain the heat of the hot metal longer than a metal mold. Continuous rapid pouring can overheat and burn a rubber mold.

## Using Multipart Molds

Complex figures must be cast in a slightly different way. For example, you might have created a figure of a man holding a flag in front of his body with his right hand. This figure cannot be cast as it was sculpted because the out-thrust arms cannot be released from the mold without destroying the mold. To avoid this, the right arm is carefully sawn off the sculpture and cast as a separate piece. Here's how:

**Step 1**—Center the figure's body in the mold, with the right arm placed nearby and off to one side and a connector called a "gate" dug between the two pieces. This permits the molten metal to flow from the body, along the gate, and into the component.

**Step 2**—Since you know that the figure's arm must be assembled onto the body, put a dab of clay on the inside of the arm at the shoulder joint and fashion it into a small pin. Place a small depression, the size of the pin, in the figure where the arm will attach. Once the mold is cast, file the arm into its finished shape and attach it to the torso using two-part epoxy glue.

The flagpole is cast as a separate item and attached to the figure later. Use paper to make the flag, and paint it using acrylic or enamel hobby paint.

# The Blacksmith

## Option 4

When the Worshipful Company of Blacksmiths, a craft guild, was formed in London during the twelfth century, its motto was “By hammer and hand, all arts do stand.” This was not an idle boast. Before the availability of less-expensive machine-made products drove them out of business during the industrial revolution, blacksmiths were truly important craftsmen because they made the iron and steel tools that were used by other craftsmen. They also made all the iron hardware and kitchen equipment that was used by people from all walks of life. Some blacksmiths in large cities concentrated upon making artistic items for use by architects and builders, specializing in making ornamental ironwork such as fences, gates, railings, balconies, and elegant sign frames.

Today there is a tremendous interest in preserving this craft. In addition to the smiths who are working to rediscover the techniques of the old masters, today’s blacksmiths are also artists, making all sorts of imaginative things from hot steel.

Because of the high temperatures generated by the forge, Scouts who select this option must work under direct adult supervision.

### Basic Blacksmithing Tools

The blacksmith’s tools have remained unchanged for thousands of years, and the blacksmith still uses the most basic elements—fire, water, and iron—to fashion both practical objects and objects of art.

Although an *anvil* is a sturdy chunk of metal, it is not a tool that can be abused with arbitrary or purposeless hammer blows. Doing so will leave pits and marks on the working surfaces that will show up on worked objects. Never strike the anvil directly



with a hammer. Always have a piece of metal between the hammer and the anvil to avoid making dents and dings.

The anvil's step is used for cutting metal, so it most likely will have dings and chisel marks. The face is where most of the work is done, so it must be kept free of any marks and imperfections. The heel has a square hole called the hardie hole and a round hole called the pritchel hole.

A *hardie* is a chisel-shaped tool with a square shank that sits in the hardie hole and is used with a hammer to cut iron and steel. A *pritchel* is a round punch; therefore, the pritchel hole is used to punch holes in hot iron and steel. The horn of the anvil is used to create scrolls and bend curves in bar stock.

The leg vise is used to bend and twist hot iron and steel. The long leg sits in a cup attached to the shop floor. This gives the leg vise extra power to resist hard blows when bending large pieces of metal with a sledgehammer.

The modern blacksmith's *forge* has an electric bellows attached to the firepot by a short length of sheet steel pipe. By burning soft coal with a steady stream of air from the bellows, the forge fire can reach 3000 degrees. When forging, keep the steel between 1400 degrees and 1800 degrees. Low-carbon steel burns at about 2200 degrees. Because the forge fire generates such high temperatures, always be alert to avoid burning the steel.

The *cross peen hammer* is the blacksmith's heavy forging hammer. Large *ball peen hammers* are also used to forge out items on the anvil.

If work is not planned properly and stock is cut too short to be hand-held while forging, *tongs* will be necessary. The tongs used most often have flat jaws to hold flat or square stock or curved jaws to hold round stock. Some tongs have a square groove to make it possible to grasp small-diameter square or round bars. Blacksmiths often make their own tongs to hold objects with unusual shapes such as ax heads.

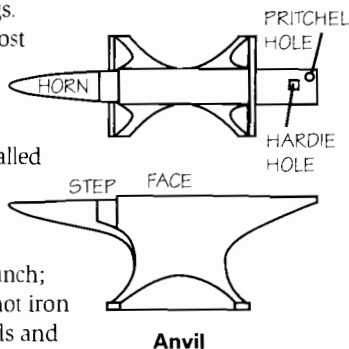

## Basic Blacksmithing Skills

Naturally, there are some fundamental techniques that must be learned before making anything at the anvil. Because there isn't room in this pamphlet for a complete treatment of the subject, only the most basic information and techniques are presented here.



## Forging a Taper

To forge a taper, hammer the end of a hot bar into a tapered point like that of a center punch. To avoid having to use tongs, cut a length of bar long enough to permit holding the cool end in your gloved hand when forging. To make the taper, tilt the hammerhead and hit the hot bar with angled blows.

Hit the hot end once and then rotate the bar 90 degrees and hit it again. Repeat this process of hitting and rotating the bar back and forth, forcing the hot steel into a taper. This action is called *tumbling*. Think, “hit, rotate 90 degrees, hit, rotate 90 degrees,” and so on until the taper is completed.



## Using the Horn of the Anvil

Position the hot steel on the horn so that the hot portion juts outward past the horn. Strike the hot section a soft blow, forcing it to bend over the curve of the horn. To keep from flattening the metal, avoid hitting it straight down on the horn. Always hit the metal beyond where it touches the horn.

**Hot steel can be bent over the horn of an anvil.**

### Using the Edge of the Anvil

Use the edge of the anvil to make L-shaped bends in objects. Heat the spot to be bent to an orange heat. Position the hot spot on the outside edge of the anvil, letting the cooler tip project over the anvil. Tap the end of the bar with a hammer, forcing the hot spot to bend over the edge. To square up the bend, tap the bend at the edge of the anvil, just beneath the bend. Be careful not to strike the bend at the corner of the anvil or you will squash the material there, weakening the piece.

### Twisting Steel

Twisting is used to put a decorative element in square and flat stock. Heat a bar to an even orange color where the twist should appear. Clamp one end of the hot steel bar in the vise, grab the other end near the hot section with tongs or a bar twister, and rotate the bar 360 degrees. An even heat means an even spiral.

### Preserving Your Work

Paraffin wax makes a fine preservative. Be sure that you are wearing gloves because the metal will still be quite warm. Rub a candle stub over your work while it is still warm, letting the liquid wax flow into all the crevices. Be careful not to overheat your work because the wax will evaporate or burn off, which is ineffective. Just before the wax hardens, rub off the excess wax with a shop rag.



Using the edge of the anvil



Twisting steel

## Blacksmithing Projects

The following projects are practical objects that a Scout can use while camping. Because the creation of art is personal to each artist, no art objects are illustrated. If you prefer to be artistic rather than practical, use your imagination and remember to apply the basic metalworking techniques.

### Basic Tools Needed

- 125-pound anvil (minimum)
- Stumps (one for the anvil; one much taller one for the vise)
- Two turnbuckles for securing anvil to stump
- Two 12-inch lengths of welded-link chain to pass over the anvil's feet and connect to the turnbuckles
- Two eye screws to secure the turnbuckles to the stump
- Leg vise or large machinist's vise
- Firepot
- Metal forge top with legs
- Mechanical bellows
- Bellows pipe
- Measuring tape or folding rule
- Soapstone pencils (for marking steel)
- 24-ounce cross peen hammer
- 12-ounce ball peen hammer
- Hot hardie
- Cold hardie
- Flat-jawed tongs
- ¼-inch and ⅜-inch bolt tongs
- Pea-sized soft coal, approximately 50 pounds per eight-hour day
- C-clamp or locking-grip pliers
- Center punch
- Drill press
- Drill, sized to match the diameter of the nails used as rivets
- Shop apron
- Leather gloves
- Safety glasses

## Materials

- ¼-inch by ½-inch flat, mild steel (C1020, A36, or equivalent)
- ¼-inch diameter mild steel (C1020, A36, or equivalent)
- ¼-inch or ⅜-inch square mild steel (C1020, A36, or equivalent)
- ⅜-inch round or square medium-carbon steel (C1065, W1, or equivalent)
- ¼-inch square, or ¼-inch by ½-inch flat, medium carbon steel
- Tenpenny or larger nails
- Candle stubs
- Cooking oil

## Forging a Dutch Oven Lid Lifter

**Step 1**—Cut a 16-inch length from a piece of ¼-inch square mild steel.

**Step 2**—Heat the center of the bar to an orange heat. Using tongs, transfer the piece from the fire to the workbench and clamp it in the vise. Place a 90-degree bend in the center.

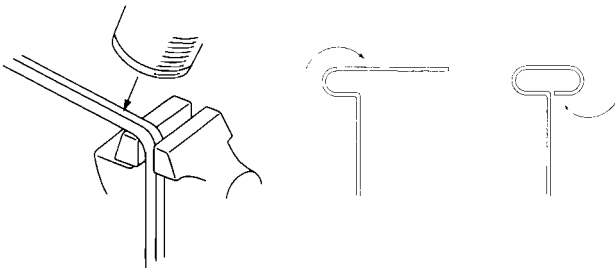

**Step 3**—Grasp the piece with tongs and reheat it. Without touching the hot metal, forge a T-handle in one end. Make sure the handle is big enough for all of your fingers to fit inside without touching or grazing the hot Dutch oven. Use tongs or the horn of the anvil when making these bends.

**Step 4**—Return the piece to the fire and bring the end of the shaft to an orange heat.

**Step 5**—Remove the piece from the fire and forge a taper in the end of the shaft. Flatten the taper.

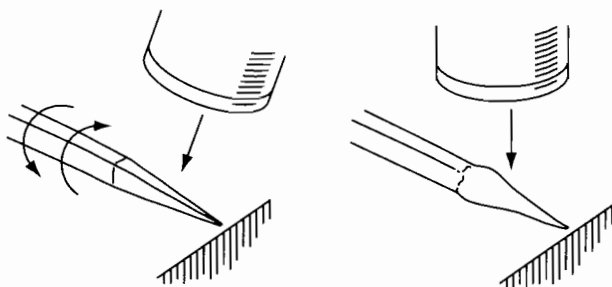

**Step 6**—Carefully reheat the flared taper and bend it 30 degrees by tapping it over the edge of the anvil. Bend the tip back.

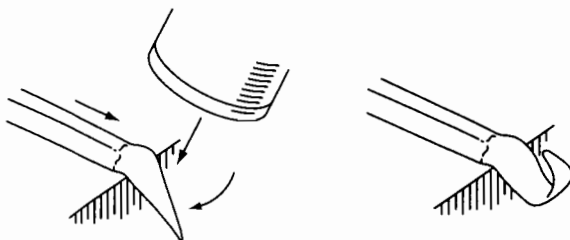

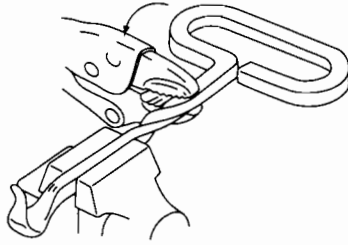

**Step 7**—Reheat the shaft and place a decorative twist in it.

**Step 8**—Wearing gloves to protect your hands from the still-warm metal, rub a candle stub over the finished piece to preserve your work. Just before the wax hardens, remove the excess with a rag.

### **Forging a Dutch Oven Trivet**

**Step 1**—Cut three 7-inch pieces of  $\frac{1}{2}$ -inch by  $\frac{1}{4}$ -inch mild steel.

**Step 2**—Heat the tips to an orange heat and clamp the bottom  $\frac{1}{2}$  inch in the vise. Bend the tips of all three of them over the edge of the vise and around in a loop. Cool the pieces.

**Step 3**—Reheat the pieces. Hook the bends under the vise jaw and bend them upward like an elephant with a raised trunk.

**Step 4**—Let the pieces *air-cool* for at least an hour.

**Step 5**—Stack the pieces and clamp them firmly together. Use the center punch to place a mark in the steel about  $\frac{1}{2}$  inch up from the unbent ends and in the center of the bar. Using the mark as a guide to keep the drill bit from wandering, drill a hole through all three pieces at the same time. This ensures that all three holes line up and that the legs will nest correctly.

**Step 6**—Slide a nail into the drilled hole and mark the shaft about  $\frac{3}{16}$  inch above the top of the hole.

**Step 7**—If you are right-handed, clamp the shank of the nail in a vise with the nail head sticking out on the right side of the vise jaw. Make sure that the mark you made on the shank of the nail sticks out past the edge of the vise jaw (at least the distance of the thickness of the hacksaw blade). Place the hacksaw blade to the left of the mark and then saw off the head of the nail.

**Step 8**—Take the pieces to the anvil and slide the nail into place.

**Step 9**—Using the peen end of a ball peen hammer, strike in a circle around the protruding shaft of the nail, creating a mushroom shape. This is called “upsetting” the metal because the metal is thickened and shortened on the end. Gradually increase the size of the mushroom until the rivet has thickened enough to keep the legs firmly attached without any wobbling. Don’t overdo it here—you don’t want to thicken the rivet’s shank so much that the legs are locked in place, making it impossible to pivot the legs around the rivet. You want the legs free to rotate so that the three legs of the trivet can be nested together and stored inside a Dutch oven.

**Step 10**—Lubricate the trivet with cooking oil to prevent it from rusting.

Spread the trivet’s legs to use the lid of the Dutch oven as a frying pan. Fold the legs and place the trivet in the Dutch oven for storage.



# Glossary

**alloy.** A substance having metallic properties and being composed of two or more chemical elements of which at least one is an elemental metal.

**annealing.** A treatment consisting of heating to and holding at a suitable temperature followed by cooling at a suitable rate, used primarily to soften metals but also to simultaneously produce desired changes in other properties.

**anvil.** A heavy iron block with a steel face upon which metal is shaped with a hammer.

**bench pin.** A rectangular wooden board clamped to a workbench used by jewelers to control a piece when using a jeweler's saw or needle file.

**blackening.** The act of applying carbon such as candle soot to a metal mold or applying graphite dust to a rubber mold. The carbon acts as a releasing agent, making it easier to extract the cooled casting from the smaller recesses of the mold.

**bouge.** The curved portion of a plate or a tray from the edge of the rim to the bottom of the plate or tray.

**brazing.** Joining metals by flowing a thin layer (capillary thickness) of nonferrous filler metal into the space between them. Bonding results from the contact produced by the dissolution of a small amount of base metal in the molten filler metal without fusion of the base metal. Sometimes the filler metal is put in place as a thin solid sheet or as a clad layer, and the composite is heated, as in furnace *brazing*. The term *brazing* is used where the temperature exceeds some arbitrary value, such as 800 degrees; the term *soldering* is used when the temperature is lower than the arbitrary value.



**anvil**

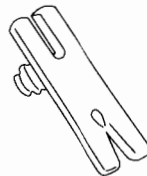

**bench pin**

**casting.** (1) An object at or near finished shape obtained by solidification of a substance in a mold. (2) Pouring molten metal into a mold to produce an object of a desired shape.

**corrosion.** The deterioration of a metal by a chemical or an electrochemical reaction to oxygen present in its environment.

**cross peen hammer.** A hammer where the peen (the end that comes to a blunt taper) runs from left to right with reference to the face. Also called a blacksmith's hammer or an engineer's hammer.

**crucible.** A vessel made of a material such as porcelain that can withstand high temperatures without cracking, used for melting a substance that requires a high degree of heat.

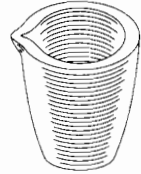

**crucible**

**crystal.** A solid composed of atoms, ions, or molecules arranged in a pattern that is repetitive and three-dimensional.

**cure.** To allow the hardening process to run its course by letting the piece rest for a period of time.

**dross.** The impurities that form on the surface of molten metal.

**ductility.** The ability of a metal to deform plastically without fracturing, being measured by elongation or reduction of area in a tensile test or by other means.

**elasticity.** That property of a material by virtue of which it tends to recover its original size and shape after deformation.

**ferrous.** Of, relating to, or containing iron.

**flux.** A substance used to clean away impurities caused by oxidation during soldering or brazing. Solder will only adhere to the metal where flux has been applied.

**forced-draft fire.** A fire where air is deliberately introduced through some mechanical means (such as a bellows) to significantly increase the rate of combustion.

**forge.** A furnace where bars of metal are heated prior to being hammered on an anvil. The shop that houses this furnace is also called a forge.

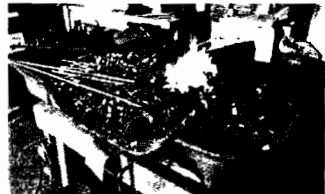

**forge**

**foundry.** A furnace where metals are heated to the liquid state prior to being poured into a mold (casting). The shop that houses this furnace is also called a foundry.

**hardie.** A blacksmith's chisel-like tool that fits in an anvil's square hole (the hardie hole) and used to part bars of metal. To part a bar of metal with a hardie, a smith lays the metal over the hardie's chisel-shaped end and strikes the metal with a hammer.

**hardness.** Resistance of metal to plastic deformation, usually by indentation. However, the term may also refer to stiffness or temper, or to resistance to scratching, abrasion, or cutting.

**hem.** To fold a small portion (between  $\frac{1}{16}$  inch and  $\frac{1}{8}$  inch) of the edge of a piece of sheet metal back upon itself. Hemming acts to both stiffen the sheet metal and to create a safe edge, preventing cuts.

**malleability.** The characteristic of metals that permits plastic deformation in compression without rupture.

**mallet.** A hammer with a barrel-shaped head made of wood.

**melting point.** The temperature at which a solid begins the transformation into a liquid.

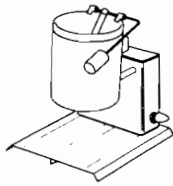

**melting pot**

**melting pot.** A sturdy vessel (usually metal) used to melt metal.

**metal.** An opaque lustrous elemental chemical substance that is a good conductor of heat and electricity and, when polished, a good reflector of light. Most elemental metals are malleable and ductile, and generally heavier than the other elemental substances.

**metallurgy.** The science and technology of metals. Process metallurgy is concerned with the extraction of metals from their ores and with the refining of metals. Physical metallurgy deals with the physical and mechanical properties of metals as affected by composition, mechanical working, and heat treatment.

**mold.** A cavity in which a substance is shaped. It is used in the casting of molten metal.

**native metal.** A metal that occurs naturally in a nearly pure form. Gold nuggets are an example of a native metal.

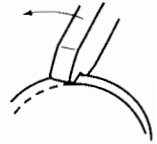

**hem**



**mallet**



**mold**



**parting line**

**nonferrous.** Of, or relating to, metals other than iron.

**ore.** A natural mineral that may be mined and treated for the extraction of any of its components, metallic or otherwise.

**oxidation.** A thin layer of rust or corrosion that forms on the surface of unprotected metal because of the metal's interaction with oxygen in the atmosphere.

**parting line.** The horizontal line formed where the two halves of a two-piece mold meet. A parting line is often placed at an object's halfway point when viewing the object from the side.

**pattern.** (1) A three-dimensional model used for making the cavity in a mold into which molten metal is to be poured to form a casting. (2) A piece of stiff paper or light-gauge sheet metal that has been cut to conform to the outlines of a component part of a sheet metal project. The craftsperson then traces the paper or metal pattern's outline onto the sheet metal from which the component part is to be constructed.

**pickling solution.** Any of various baths used to clean metal. One of the pickles used by silversmiths is a 10 percent sulfuric acid, 90 percent water solution. A pickling solution is most often used to remove the metal oxide that has formed on the surface of silver. Pickling solutions also will remove the flux used to solder seams.

**planishing.** The process of hammering or refining a metal surface.

**platewell.** The flat bottom of a tray or plate into which the bouge runs.

**quench.** To cool (as in heated metal) by immersion (as in oil or water).

**raising.** The process of creating a hollow form from a flat sheet of metal by forming it over a cast-iron stake.

**rivet.** A mechanical fastener that is hammered in place.

**rolling.** The process of transforming a lump of metal into a bar or a sheet.



**quench**



**rivet**



**raising hammer**

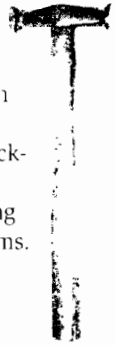

**planishing hammer**

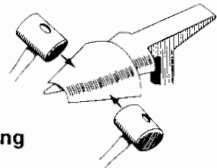

**rolling**

**seaming.** Connecting two pieces of sheet metal without welding. Seams are soldered or brazed to ensure that the joint remains together.

**sinking.** The process of creating a concave shape from a flat piece of metal by hammering the metal over the top of a shaped form (**sinking block**).



**sinking block**

**smelting.** A metalworker's term for exposing ore-bearing rocks to high temperature to separate the metal from the rock.

**sprue.** The hole through which metal is poured into the mold during the casting process.

**soldering.** Similar to brazing, but the filler metal has a melting temperature range below an arbitrary 800 degrees. Soft solders (low melting point) are usually lead-tin alloys, although pure-tin solders are available and are recommended.

**stake anvil.** A polished cast-iron or steel tool placed in a vise and used during the forming and planishing of metal.



**mushroom  
stake anvil**

**steel.** Commercial iron that contains carbon in any amount up to about 1.7 percent as an essential alloying constituent. It is malleable under suitable conditions, and is distinguished from cast iron by its malleability and lower carbon content.

**tempering.** The process of relaxing the brittleness of a water- or oil-hardened steel by reheating it at a lower temperature.

**tumbling.** The process of alternately rolling and hammering the end of a bar of hot metal to forge a taper.

**twisting.** The process of making a decorative spiral in square, hexagonal, or octagonal metal.

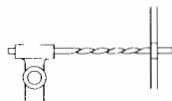

**twisting**

**vents.** Small tunnels placed in molds to conduct air out of a mold during the casting process. Unless vented, trapped air has nowhere to go and its presence will prevent the molten metal from flowing into portions of the mold.

**work hardening.** The process of hardening a metal by hammering it.

**yield point.** The point at which a crystal under pressure has been transformed to such a state that, when the transforming pressure is released, the crystal cannot return to its original condition.

# Metalwork Resources

The resources listed below represent only a fraction of those available to the hobby metalworker. Check the local library and bookstores for additional titles, and don't be afraid to purchase out-of-print titles or titles with older copyright dates—the majority of metalworking techniques are timeless.

## Books

### Metalworking

Almeida, Oscar. *Metalworking*. New York: Drake Publishers, Inc., 1971. (ISBN 0-87749-077-5)

McCreight, Tim. *The Complete Metalsmith: An Illustrated Handbook*. Davis Publications: 1991. (ISBN 0-871922-40-1)

Walker, John R. *Modern Metalworking*. South Holland, Illinois: Goodheart-Wilcox Company, Inc., 1993. (ISBN 0-87006-040-6)

### Metal Can Craft

Elliot, Marion, and Peter Williams. *Tinwork*. London: Laurent Books, 1996. (ISBN 1-83967-143-8)

Hansson, Bobby. *The Fine Art of the Tin Can*. Asheville, North Carolina: Lark Books, 1996. (ISBN 1-887374-02-7)

Maguire, Mary. *Tin Crafts—Over 20 Projects for the Home*. London/New York: Lorenz Books, 1999. (ISBN 1-85967-886-6)

### Tinsmithing/Tinware

DeVoe, Shirley Spaulding. *The Art of the Tinsmith—English and American*. Exton, Pennsylvania: Schiffer Publishing, Ltd., 1981. (ISBN 0-196838-59-5)

Handsberg, Ejner. *Shop Drawings of Shaker Iron and Tinware*. Berkshire House Publishing, 1993. (ISBN 0-936399-45-7)

### Silversmithing

McCreight, Tim. *Jewelry—The Fundamentals of Metalsmithing*. Madison, Wisconsin: Hand Books Press, 1997. (ISBN 1-880140-29-2)

McCreight, Tim. *The Metalsmith's Book of Boxes and Lockets*. Madison, Wisconsin: Hand Books Press, 1999. (ISBN 0-9658248-9-6)

Finegold, Rupert, and William Seitz.  
*Silversmithing*. Iola, Wisconsin:  
Krouse Publications, 1983.  
(ISBN 0-8019-7232-9)

## Metal Casting

Ammen, C. W. *The Complete Book of  
Bronze Casting*. Blue Ridge Summit,  
Pennsylvania: Tab Books Inc., 1983.  
(ISBN 0-830610-43-X)

McCreight, Tim. *Practical Casting*.  
Brynmorgan Press: 1994.  
(ISBN 0-961598-45-X)

## Blacksmithing

Andrews, Jack. *The New Edge of  
the Anvil*. Ocean Pines, Maryland:  
Skipjack Press, 1994.  
(ISBN 1-879535-09-2)

Blandford, Percy. *The Practical  
Handbook of Blacksmithing  
and Metalworking*. Blue Ridge  
Summit, Pennsylvania: Tabb Books,  
Inc., 1980. (ISBN 0-8306-9947-3)

Weygers, Alexander, G. *The Complete  
Modern Blacksmith*. Berkeley,  
California: Ten Speed Press, 1997.  
(ISBN 0-89815-896-6)

## Web Sites

Artist-Blacksmith's Association of North  
America (ABANA) <http://abana.org>

The ArtMetal Resource to Metalworking  
[http://www.artmetal.com/project/AM\\_res.html](http://www.artmetal.com/project/AM_res.html)

National Ornamental Metal Museum,  
Memphis, Tennessee  
<http://www.metalmuseum.org/>

Society of American Silversmiths  
<http://www.silversmithing.com>

## Materials and Supplies

### Metalworking Supplies

Covell Creative Metalworking  
106 Airport Blvd.  
Freedom, CA 95019  
Telephone: 800-747-4631 or  
831-768-0705

This company sells fine-quality  
metalworking tools by mail order all  
over the world. It also carries excellent  
instructional videotapes covering many  
aspects of metalworking. Send \$1 for  
a catalog.

Rio Grande  
4516 Anaheim Ave. NE  
Albuquerque, NM 87109  
Telephone: 800-545-6566  
Web site: <http://www.riogrande.com>

An excellent source of silver-  
smithing supplies and metal, the com-  
pany catalog is available.

Shor International Corporation  
20 Parkway West  
Mount Vernon, NY 10552  
Telephone: 914-667-1100  
Fax: 914-667-0190  
Web site:

<http://www.shorinternational.com>

E-mail:  
[shorinternational@worldnet.att.net](mailto:shorinternational@worldnet.att.net)

This company has offered fine tools  
and innovative machines since 1918. It  
is an excellent resource for the silver-  
smith and art metalsmith.

Stebgo Metals  
P.O. Box 65368  
St. Paul, MN 55165  
Telephone: 800-289-0138  
Fax: 612-451-1397

This company's catalog offers wholesale tools and metals.

Widget Supply  
P.O. Box 3282  
Albany, OR 97321  
Telephone: 541-924-8882  
Web site: <http://www.widgetsupply.com/>

This company carries hobby tools, Dremel® tools, and inexpensive metal-working hammers.

### **Casting Metal, RTV Silicone, Premade Molds**

Castings  
P.O. Box 298  
Eastsound, WA 98245-0298  
Telephone: 800-346-0567 or  
360-376-3266  
Web site:

<http://www.miniaturemolds.com>

This company carries starter supplies, molds of historic figures, metal ingots, liquid RTV silicone, tools, and instructions. A catalog is available.

The Dunken Company, Inc.  
P.O. Box 526  
Willis, TX 77378  
Telephone: 800-544-6653  
Fax: 979-364-2218  
Web site: <http://www.dunken.com>

This company carries starter supplies, metal ingots, and molds of historic figures. A catalog is available.

### **Blacksmith Supplies**

Centaur Forge  
117 North Spring St.  
P.O. Box 340  
Burlington, WI 53105-0340  
Telephone: 800-666-9175 or  
414-763-9175  
Web site: <http://www.centaurforge.com/>

### **Acknowledgments**

This edition of the *Metalwork* merit badge pamphlet was written by Andrew G. Hagemann, Eagle Scout 1969. The author is grateful to many contributors for sharing their resources and expertise:

- Jack Andrews
- The Castings Company
- Doug Learn and the Artist-Blacksmith's Association of North America (ABANA)
- Stewart Marshall, Queen's Scout
- Timothy McCreight
- Dezso and Desmond Rubesch

A special thanks to Kenneth Hampton, Eagle Scout 1952, for his invaluable assistance with the how-to drawings used in the pamphlet.

The Boy Scouts of America also gratefully acknowledges the assistance of the Colonial Virginia Council, Newport News, Virginia.

### **Photo Credit**

Courtesy of Bethlehem Steel Corporation—page 13