

# GRAPHIC ARTS



BOY SCOUTS OF AMERICA  
IRVING, TEXAS

# Requirements

1. Review with your counselor the processes for producing printed communications: offset lithography, screen printing, electronic/digital, relief, and gravure. Collect samples of three products, each one produced using a different printing process, or draw diagrams to help with your description.
2. Explain the differences between continuous tone, line, and halftone artwork. Describe how it can be created and/or stored in a computer.
3. Design a printed piece (flier, T-shirt, program, form, etc.) and produce it. Explain your decisions for the typeface or typefaces you use and the way you arrange the elements in your design. Explain which printing process is best suited for printing your design. If desktop publishing is available, identify what hardware and software would be appropriate for outputting your design.
4. Produce the design you created for requirement 3 using one of the following printing processes:
  - a. **Offset lithography.** Make a layout, and produce a plate using a process approved by your counselor. Run the plate and print at least 50 copies.
  - b. **Screen printing.** Make a hand-cut or photographic stencil and attach it to a screen that you have prepared. Mask the screen and print at least 20 copies.

- c. **Electronic/digital printing.** Using both text and graphics, create a layout in electronic form, download it to the press or printer, and run 50 copies.
  - d. **Relief printing.** Prepare a layout or set the necessary type. Make a plate or lock up the form. Use this to print 50 copies.
5. Review the following postpress operations with your counselor:
- a. Discuss the finishing operations of padding, drilling, cutting, and trimming.
  - b. Collect, describe, or identify examples of the following types of binding: perfect, spiral, plastic comb, saddle-stitched, and case.
6. Do ONE of the following, then describe the highlights of your visit:
- a. Visit a newspaper printing plant. Follow a story from the editor to the press.
  - b. Visit a retail, commercial, or in-plant printing facility. Follow a project from beginning to end.
  - c. Visit a school's graphic arts program. Find out what courses are available and what the prerequisites are.
  - d. Visit three Web sites (with your parent's permission) that belong to graphic arts professional organizations and/or printing-related companies (suppliers, manufacturers, printers). With permission from your parent or counselor, print out or download product or service information from two of the sites.
7. Find out about three career opportunities in graphic arts. Pick one and find out the education, training, and experience required for this profession. Discuss this with your counselor, and explain why this profession might interest you.



## Contents

Graphic Communications Today . . . . .	7
The Evolution of the Graphic Arts . . . . .	9
The Major Printing Processes . . . . .	16
Preparing to Print . . . . .	44
Making the Layout . . . . .	61
Bindery and Finishing Operations . . . . .	69
Careers in the Graphic Arts . . . . .	77
Graphic Arts Resources . . . . .	86



This pamphlet will give you an introduction to the graphic arts. You will be involved in your own hands-on creation of a printed piece, from start to finish. Your merit badge counselor will help you get started and will answer any questions you have that are not covered in this pamphlet. Your counselor may also be able to help you locate the materials and equipment you need.

# Graphic Communications Today

The field of graphic arts includes many kinds of work in the printing and publishing industries. Graphic arts professionals are involved in the creation of all kinds of printed communication, from business cards to books to billboards. The scope of printing communications is huge.

What many people think of as printing—putting ink on a sheet of paper—has undergone so many dramatic changes that even its name has changed. The term used most often today is *graphic communications*. This includes all of the processes, materials, related fields, and people necessary to reproduce words, ideas, pictures, and symbols into a printed form so that others may see and react to them.

Greeting cards, bumper stickers, menus, cereal boxes, street signs, candy wrappers—the list is endless. Just about anything you can think of calls for some type of graphic arts treatment. For example, the production of a colorful, eye-catching poster could start with a graphic designer who works with a client's idea and message. The designer plans the way the poster will look and selects the typefaces, colors, paper, and printing process. Artists could work on the project, too, by creating illustrations. Skilled technicians prepare the piece for printing, operate printing equipment, carefully watch the results, and make adjustments to get the best quality in every poster.

Graphic arts professionals produce all sorts of printed materials that communicate in their own ways. You will discover how graphic arts affects us all, whether or not we realize it.

---

The word *graphic* comes from the Greek word *graphein*, which means “to write.” Anything that is presented as written words or pictures is *graphic*.

---





# The Evolution of the Graphic Arts

The story of graphic communications begins with the rock paintings people used long ago as a simple means of communication. Over time, people developed standardized writing systems to communicate. The invention of the printing press in the 1400s was a major turning point in the history of graphic arts, as it made mass production of printed materials possible for the first time. The advent of computers in the late 20th century marked another watershed in the history of graphic communications, enabling printers to use digital processes to set pages of text and graphics with less effort and greater speed.

## From Pictures to Writing Systems

No one knows exactly how long ago humans started to create pictures for others to see and understand, but paintings on rocks and cave walls are early examples. Some archaeologists believe cave paintings found near Avignon, France, to be more than 30,000 years old. Primitive drawings on rock have been found on every continent except Antarctica.

Thousands of years ago, several civilizations developed picture writing systems. A simple drawing, called a *pictograph*, stood for an object, a person, or an action. A combination of pictographs told a story or recorded information.



**Ancient pictographs on clay tablets**

In Sumer (an area in present-day Iraq), writers used a writing tool made of bone, wood, or reed to mark on a soft clay tablet, which later dried and made a permanent record. A simple drawing of the head of an ox and three dots recorded three oxen. Pictographs evolved into symbols that stood for words in a writing system called *cuneiform* (kyoo-NEE-ih-form) writing. People who spoke different languages adapted this system for their writing.



**Cuneiform tablet**

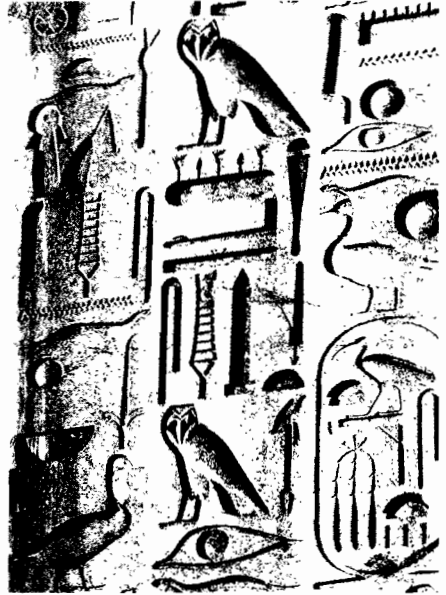

**Egyptian hieroglyphs**

The ancient Egyptians used a picture-writing system called *hieroglyphics*. Each hieroglyph was a symbol that represented an object or idea.

Several thousand years ago, the Chinese created a writing system with thousands of characters representing objects, ideas, and sounds. They have kept this system, modernizing the characters and adding new ones over hundreds of years.

## Next Step: The Alphabets

In an alphabet, a letter stands for a sound. Different cultures formed alphabets based on cuneiform script and Egyptian hieroglyphics.

The Phoenicians (fuh-NEE-shuns), who lived along the coast of what is now Lebanon and Syria, were sailors and traders who explored the Mediterranean Sea. Their alphabet, believed to be developed about 1200 B.C., traveled with them and spread to Spain and Greece.

Historians believe the Greeks formed their alphabet around 800 B.C., adapting signs from the Phoenician alphabet and assigning vowel sounds to some of the Phoenician characters. They also added new letters.

Next, the Romans based their alphabet on the Greek alphabet. They changed the design of some letters and added a few new ones. The Roman alphabet is the one we use for English and western European languages.



## Printing Begins

Before the invention of printing methods, documents and books were produced by hand. Each copy was handwritten by a writer known as a scribe. It was a slow process, so books were not widely available. There had to be a faster way.

The Chinese invented a way of printing in about A.D. 500, by carving a wooden block with a whole page of text. The characters were carved in *relief*, that is, the carver cut out the area around each character, leaving the character raised up from the background. (If you have ever used a rubber stamp, the letters or pictures on the stamp are in relief.) The characters were also carved in reverse. When the printer inked the block and placed a sheet of paper on it, the result was a page that read correctly. The Chinese used woodblocks to print books in the form of scrolls.

---

The word *alphabet* comes from the first two letters of the Greek writing system, *alpha* and *beta*.

---

---

A Buddhist  
prayer printed  
on a scroll in A.D.  
868 is thought to  
be the oldest  
complete book  
in existence.

---

A Chinese printer, Pi Sheng, made the first *movable type* between A.D. 1041 and 1049, with each character in relief on a separate piece of baked clay. Printers formed a page by arranging the type in rows in an iron frame. They inked the type, placed the paper on it, and hand-rubbed the paper to produce the printed page. After printing, the movable type could be used again, but the printing process still was very slow.

Movable type was not a lasting success. Woodblock printing again became the most widely used method in Asia, and knowledge of movable type did not reach Europe until the 1400s.

## Europe: From Manuscript Books to Printing

In European history, the period from A.D. 476 to 1453 is known as the Middle Ages. This period began with the fall of the Roman Empire. It was a time of many wars, invasions, and instability.



Books were scarce. Those that did exist were sometimes lettered on scrolls. Later books were made with pages sewn together between covers. Scribes and artists worked months, even years, copying by hand Bibles, prayer books, history books, or books about medicine or herbs. These books were called *illuminated manuscripts*, because they were illustrated with colorful pictures, borders, and other decorations called illuminations.

Only the wealthiest people could afford books. As times changed, the common people wanted more knowledge. By the 1400s, they wanted to learn to read, and they needed books.

**Many early books were decorated with colorful artwork called illuminations.**

## Gutenberg's Contribution

Johann Gutenberg (1397-1468) of Germany was a metalsmith who is credited with the inventions that introduced modern printing to Europe: cast-metal movable type and the printing press. Gutenberg made movable type by making a bar of hard steel, called a punch, and carving a letter in relief on the end of it. The letter read backwards. He stamped the punch into a block of soft copper, leaving a letter-shaped depression. This was the matrix (the mold) for the letter. He fitted pieces of wood together to make a small mold with the matrix for the letter in the bottom. Then he poured in a mixture of molten metals. When the metal hardened, he took the wooden mold apart.

The result was a slender block of metal with the letter in relief on the tip, reading backwards. Gutenberg could cast hundreds of each letter of the alphabet with this method. His wooden mold was adjustable for the narrowest and widest letters. His letters were in the text style that scribes used to hand-letter books. He even produced slight variations of each letter, so the text would look handwritten.

As time went on, printers designed type that was easier to read. Today there is a wide choice of *typefaces*, or type of a particular design, for all purposes. You will read about type choices in the "Preparing to Print" chapter.

Gutenberg turned a wooden wine press (used for crushing grapes) into a printing press. The printers inked the type, placed a sheet of paper on it, and pulled a handle that operated the press and put pressure on the paper. They removed the paper and inked again. Though printing was still a hand operation, Gutenberg made it much faster to print many copies of a book. This type of press was used for the next 350 years.

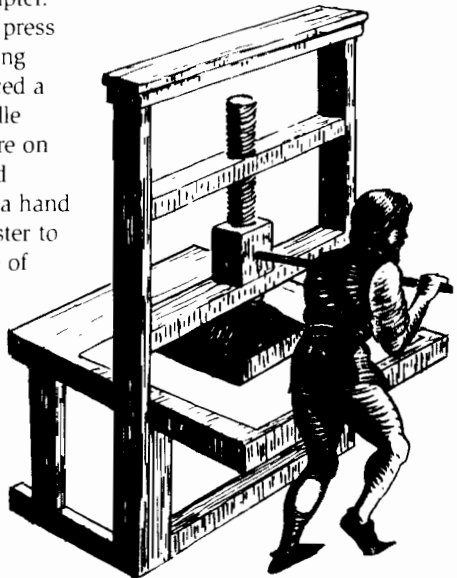

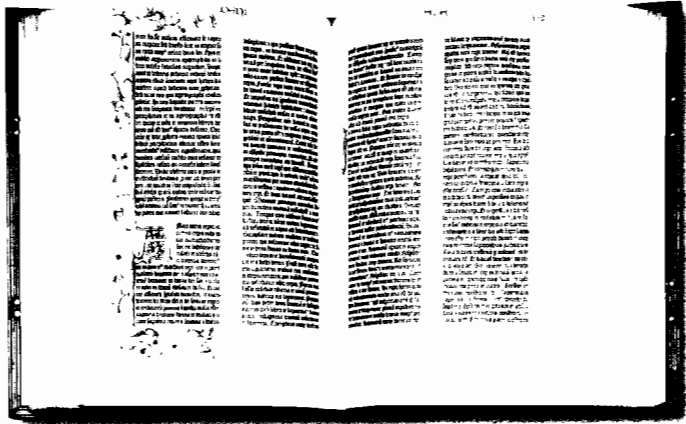

## The Gutenberg Bible

---

The earliest known page of a book printed by Gutenberg is from a Latin textbook published in 1448.

---

Gutenberg's crowning achievement was the Gutenberg Bible, published around 1455. Gutenberg and his employees used six presses to print 200 copies. Gutenberg's methods spread to printers in German towns and then to Italy, France, Holland, England, and Spain. Books, so long out of reach for most people, were now available.

Gutenberg's invention coincided with the end of the Middle Ages and the beginning of the Renaissance, a period in history when a revival of art, literature, and learning occurred throughout Europe. Gutenberg had opened the way for knowledge and communication. When he died, an inscription at his burial place called him "the inventor of the art of printing and deserv[er] of the highest honors of every nation and tongue."

## Early Printing in the Americas

The Spanish, who brought the first printing press to the New World, printed the first book in the Americas in 1539 in Mexico City.

In the British American colonies, the first press from England was set up in 1638 at Harvard College in Cambridge, Massachusetts. In 1649, master printer Samuel Green took over the press at Harvard College. In 1663, he produced the first Bible printed in the colonies. The Bible was also the first book printed in an American Indian language. It was a translation of the Bible in the language of the Algonquin tribe.

More presses were set up. Printers were often the writers, editors, and publishers of newspapers. Newspapers and the people who printed them were important in the colonies' surge toward independence. For example, John Peter Zenger, printer and editor of the *New-York Weekly Journal*, was arrested in 1734 for publishing articles that criticized the colonial governor. He was imprisoned for nine months before his trial. The jury decided that although Zenger had broken the law, he had printed the truth, so he was set free. This freed newspapers to voice the colonists' views about England's rule during the next 40 years. When the colonies gained independence from England, the Founding Fathers guaranteed freedom of the press in the U.S. Constitution.

**Benjamin Franklin (1706–1790), one of the most important Americans of all time, was apprenticed as a printer. In 1726, he bought his own print shop and wrote, printed, and sold thousands of copies of his *Poor Richard's Almanack*. Franklin published a newspaper, the *Pennsylvania Gazette*, and many books. After retiring from printing, he became a statesman and diplomat.**

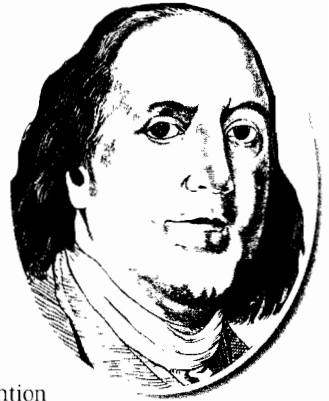

Major changes occurred in printing with the invention of the steam-powered press in 1811, which made printing four times faster. Later, the rotary press quadrupled printing speed by using rollers to feed paper across a printing cylinder.

Typesetting sped up when American inventor Ottmar Mergenthaler introduced the Linotype machine in 1886. When the operator pressed keys, the machine lined up brass molds for letters and filled them with molten lead, casting complete lines of type. After printing, the lead was melted down and reused.

As time went on, new printing processes and faster presses powered by electricity answered the need for greater mass communication. Phototypesetting in the 1950s, computer typesetting in the 1960s, desktop publishing in the 1980s, and direct-to-plate technology today have brought immense change.

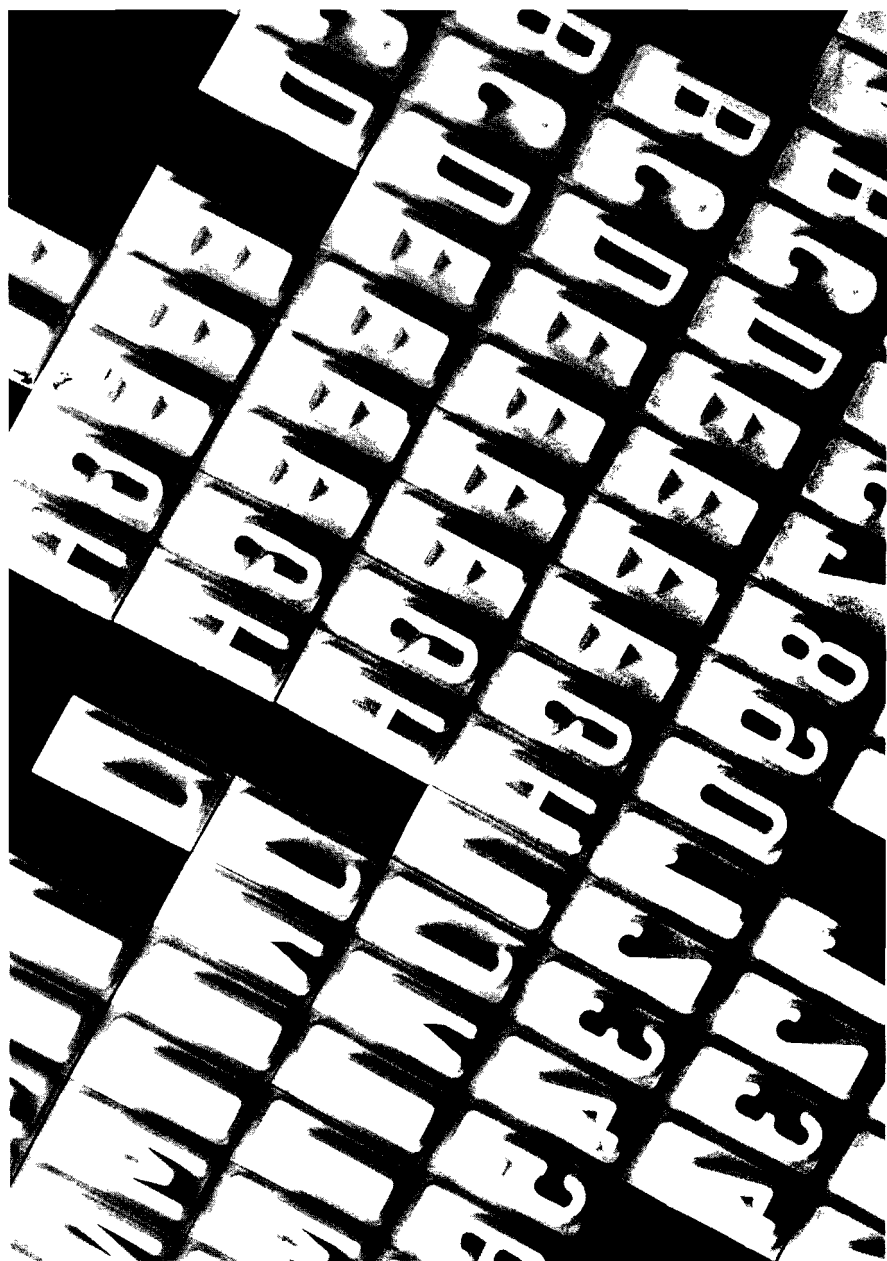



# The Major Printing Processes

The major printing processes in the graphic arts industry today can be organized into five categories: relief printing, lithography, screen printing, gravure (or rotogravure), and electronic/digital printing.

## Relief Printing

Relief printing uses a raised surface to press ink onto paper. The most common forms of relief printing are letterpress and flexography.

### Letterpress Printing

Letterpress is one of the oldest printing methods, with its origins in the movable type invented in China in the 11th century and in Germany in the 15th century. The significance of Johann Gutenberg's invention was that his movable metal type was reusable. Individual letters could be set by hand for a printing job, printed, and then taken apart and used in another project. Printers used handset type until the late 1800s.

Letterpress printing was the dominant process for 500 years, but new technologies in the last 50 years have offered better and more efficient ways to do printing. Letterpress today has taken on a more modern look. Although it is not as widely used as the other major printing processes, it is still an important method within the printing industry.

Many individual private-press printers across the country continue to use the traditional letterpress methods with equipment that is 100 years old or older. They print stationery, business cards, books, greeting cards, and fliers, and incorporate special effects such as embossing, foil stamping, and die-cutting. These processes are discussed in the "Bindery and Finishing Operations" chapter.

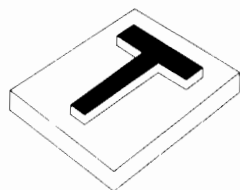

RELIEF

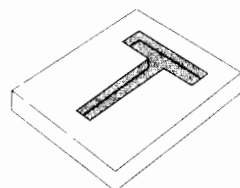

GRAVURE

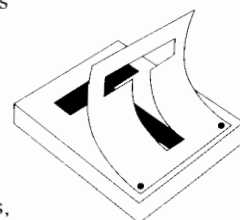

SCREEN PRINTING

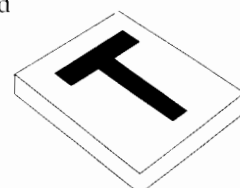

LITHOGRAPHY

In letterpress printing, a raised metal (or hard plastic) surface contains the image to be printed. This surface is coated with ink and then pressed against a piece of paper, transferring the ink to the paper.

fi	fl	3 LM	4 LM	'	k		1	2	3	4	5	6	7	8	S	c	Æ	Œ	æ	œ	
i	b	c	d	e	i	s	f	g	ff	9					A	B	C	D	E	F	G
!	l	m	n	h	o	y	p	w	^	IN QUADS	EM QUADS				H	I	K	L	M	N	O
z					a	r	:	:	2 LM AND 3 LM QUADS					P	Q	R	S	T	V	W	
x	v	u	t	3 EM SPACES										X	Y	Z	J	U	&	ffl	
q																					

### California job case

**The Type Case.** The case that held the individual letters of Gutenberg's type changed little during its first 400 years. But, in 1859, Tom Rooker of the *New York Tribune* newspaper received a patent for arranging a type case according to how frequently particular characters were used. This case is most likely the one we refer to today as the *California job case*.

The printing done by letterpress was once called *typography*, from the Greek word *typos*, meaning "impression" or "cast." Typography now refers to the style and appearance of printed matter. A typographer is a person who is skilled in the design, choice, and arrangement of type.

**The Press.** As with the type case, the printing press changed very little during its first 400 years. Printers used converted wine presses made mostly of wood. In England during the early 1800s, Lord Stanhope produced the first press completely constructed of iron. It could print a full-sized sheet.

The press that is still used today to print handset type is called a *platen press*. It works on a simple principle: A flat type surface and a sheet of paper are alternately pressed together to make an impression and moved apart to allow the type to be inked and a fresh sheet of paper to be substituted.

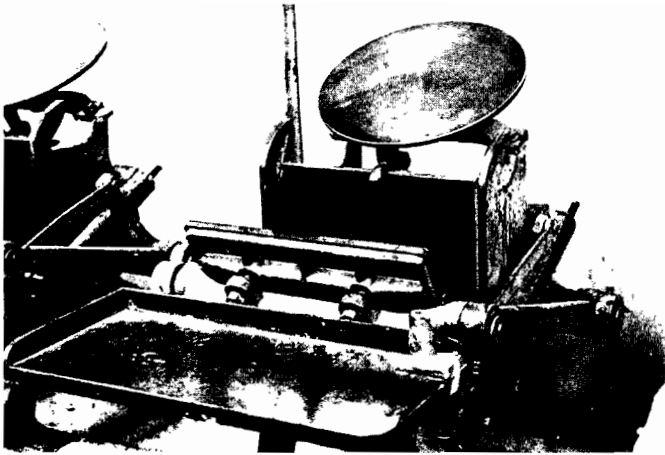

Some schools and smaller print shops still use a hand-operated platen press like the one shown here.

### PRINTING AND SAFETY

You must be careful when setting type. Check to see that the “nicks” on the individual letters are always facing up in your *composing stick*, a small adjustable tray you hold in your left hand and into which you place individual letters as you take them from the job case to form words and sentences. Choose a type font that is easy to read. Make a proof and proofread your copy before printing your final sheets. Replace each piece of type in its proper compartment within the job case.

**If you decide to use the letterpress printing process to complete your merit badge requirements, you will find that learning how to handset type will be a valuable and enjoyable experience. You also will know how printers worked hundreds of years ago.**



**Caution:** Be sure you feel comfortable with the instructions you receive about the way the platen press operates. You must operate this piece of equipment only under direct adult supervision and with total concentration because it can severely damage your hand if not operated correctly.

---

The difference between traditional letterpress and flexography is that the raised surface for flexography is made of plastic or rubber instead of metal.

---

## Flexography

First introduced in the early 20th century, flexography is one of the newer relief printing processes. It uses a flexible rubber or photopolymer plate with a raised image area to press ink onto a *substrate* (print-receiving surface). Depending on the printing project, the substrate might be paper or plastic. Using rubber stamps is a simplified flexographic printing process.

Today, modern flexography is always done on a rotary press, with the “flexo” printing plate on a cylinder. Printing by the flexographic process is ideal for the packaging industry because of the simplicity of operation and the ability to print on a wide variety of surfaces. Candy wrappers, labels, milk cartons, and gift wrap are examples of items printed with flexography.

The process consists of three major units: in-feed, printing, and out-feed units. Most flexography is done on roll-fed materials such as film, foil, and laminates used in the food industry. The inks used in flexography are much thinner than offset inks and require a much simpler inking system.

Today, flexographic plates are made using computer-generated images and a light-sensitive photopolymer resin. Layouts for flexography are converted into a high-contrast negative film. Ultraviolet light passes through the negative image and alters the resin’s molecular structure to create the flexographic plate.

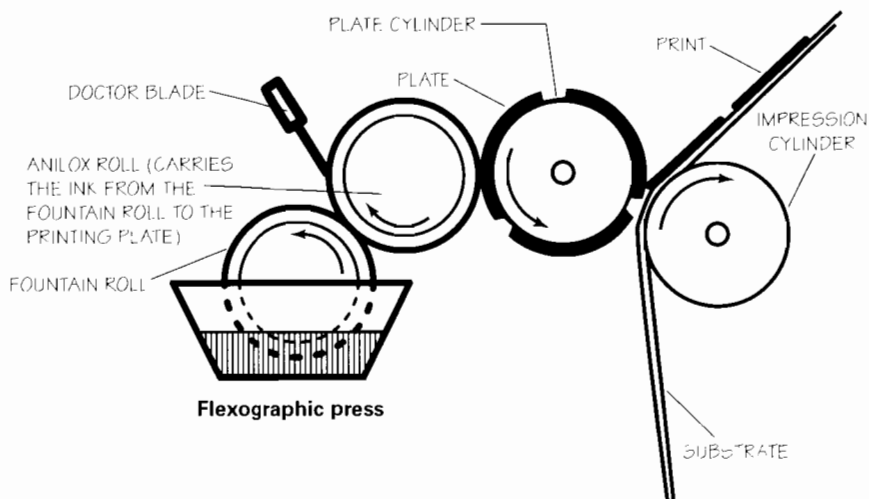

## Offset Lithography

*Lithography* is based on the principle that oil and water do not mix. The image area of a surface is chemically treated to attract oil (or grease or ink) and repel water. The nonimage part of the surface attracts water but repels oil. A wet roller runs over the printing surface, depositing water in the nonimage area and leaving the image area dry.

The lithographic process was developed by the German printer Alois Senefelder about 1798. Senefelder was looking for an inexpensive way to print plays and musical scores. Limestone was available from quarries near his home. He wrote in reverse on a flat block of stone with a piece of greasy chalk and then applied water to the entire stone. The water coated only the areas not touched by the chalk. Oil-based ink was repelled by the wet areas and attracted to the greasy image. When he placed paper in contact with the stone, the inked image transferred to the paper. Senefelder also developed a printing press to handle the heavy stone.

A second roller with an oil-based ink is also rolled over the surface. The ink from this second roller is attracted to the dry image area and repelled by the wet nonimage area. The substrate is then pressed against the printing surface, and the ink is transferred from the image area to the substrate.

The most common kind of lithographic printing today is *offset lithography*, sometimes referred to simply as *offset*. In offset lithography, the inked image is transferred (offse:) to a rubber surface called a *blanket*. The blanket is then pressed against the paper, transferring the inked image from the blanket to the paper. Products printed by offset lithography include many items on paper and paperboard. Letterhead, business cards, books, magazines, brochures, calendars, and posters are just a few examples. Offset lithography has advanced to become the most widely used printing process today.

---

*Lithography* means “stone writing” because originally the printing surface was a piece of limestone that had been ground flat. Lithography was used by many great artists in the 19th century. Today, only artists use stones; today’s lithographic printing plates are made from sheets of aluminum.

---

---

In offset printing, the ink adheres only to the image area—if the ink and moisture are in the right balance. The moisture roller and the ink rollers must operate with the correct pressure on the plate, and the amount of water and ink that is fed must be regulated.

---

**Diagram of a three-cylinder offset press. As the cylinders turn, water wets the non-image areas on the plate cylinder, and ink adheres to the image areas. The offset cylinder (blanket) picks up the ink from the plate cylinder. As the paper passes between the offset cylinder and the smooth impression cylinder, the paper picks up the image from the offset cylinder.**

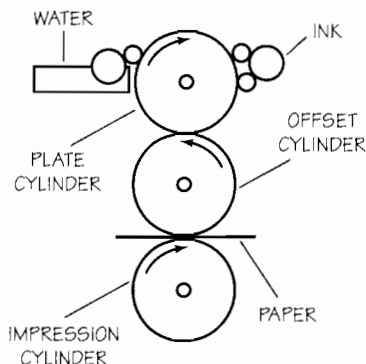

### Using Offset Lithography

If you choose to complete requirement 4 using offset lithography, you will need access to a shop that will allow you to do all the necessary steps that lead to making a plate for the press. How you make the plate will depend on what equipment is available. Review the platemaking options below and, with help from your merit badge counselor, choose the option that matches the equipment available to you. Then go on to read the details for your choice.

Here is the traditional method.

**Step 1**—Make a traditional pasteup or output a digital version to a laser printer.

**Step 2**—Make a high-contrast negative using a process camera.

**Step 3**—Strip a flat. (See the section on stripping that follows.)

**Step 4**—Expose and process the offset plate.

Use this method if you have a digital layout and an imagesetter.

**Step 1**—Output your layout to film.

**Step 2**—Strip a flat.

**Step 3**—Expose and process the plate.

If you have a digital layout and a platesetter, output your file directly to the plate material and process it.

## Stripping a Flat

Stripping is the process of attaching the negative (or negatives) to a masking sheet so everything is in the correct position for making the plate. The result of the stripping operation is called a *flat*. Stripping is done on a light table, which has a light source under a frosted white acrylic or glass surface.

The *masking sheet* can be vinyl or paper, but it must be translucent to regular light, meaning it will transmit light but not give a clear view through it. The masking sheet must block ultraviolet light and typically is a special yellow or orange paper called goldenrod.

The procedures to make a flat vary, but they generally are as follows:

**Step 1**—Square the masking sheet on the glass and draw guidelines—if guidelines are not pre-printed on the masking sheet. These guidelines serve to locate where the image can print for making the plate and for the press.

**Step 2**—Mark the *gripper bite allowance* on the edge of the paper that is going into the press first.

*Grippers* are mechanical “fingers” on the press that take hold of the paper and guide it through the press. The *gripper bite allowance*, which must be in a nonprinting area, is the space needed on the paper so the grippers have room to grab the sheet.

**Step 3**—Position the negative, squaring it to the guidelines. Tape the negative to the masking sheet, with the film base toward the sheet.

**Step 4**—Turn the flat over. Carefully cut windows in the goldenrod so light can pass through the image areas of the negative, only where you need to show the image. Do not cut the negative.

**Step 5**—Use a small paintbrush and *opaque* to cover *pinholes* (tiny transparent areas that light can get through, usually caused by dust particles) or scratches. Opaque is a red, thin, smooth liquid that keeps light from coming through the negative. Allow it to dry before handling the flat.



**Tape the negative to the goldenrod paper.**



**Turn the flat over and cut out the image area.**



**Cover any nonimage marks with opaque.**



**1**  
Insert the plate into the vacuum frame.



**2**  
Place the flat on top of the plate in the vacuum frame.

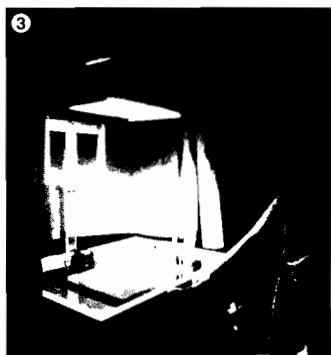

**3**  
Expose the plate to light.

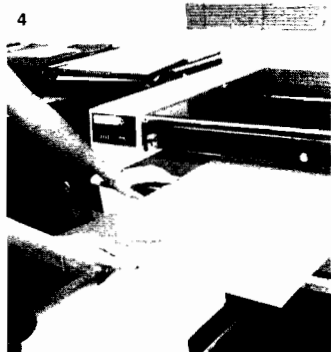

**4**  
Develop the plate.

## Platemaking

Different kinds of plates are available, depending on the length of the *press run* (the number of copies you will print) and other considerations, so follow instructions for the plate you are using. All plate surfaces are light-sensitive and should be used

under subdued or yellow light. Handle the plate on the edges to prevent fingerprints, and be careful not to scratch or bend it.

Get proper instructions on the exposure system to be used, including safety precautions. This is the general procedure.

**Step 1**—Place the plate on the base of the vacuum frame, with the light-sensitive surface up. Place the flat on top of the plate, with the text “right reading” (so you can read it) and the edges squared.

**Step 2**—Close the frame and use the vacuum system to bring the plate and flat tightly together. Check to see that the flat covers the plate and is square to it.

**Step 3**—Expose for the required time. As a safety precaution, never look directly at the light source.

**Step 4**—Develop or process the plate according to the manufacturer’s instructions. The image should be solid and even in color. Preserve the plate by spreading gum arabic on it. This gum protects the plate from corrosion during the time between when the plate is made and when it is used on the press.



## Presswork

Presswork is a major and complicated step. Make sure you understand the operation of the press and safety precautions before starting. Follow instructions closely.

Presswork preparation may vary but will include the following steps.

**Step 1**—Lubricate the press, following specifications.

**Step 2**—Load paper in the paper feed.

**Step 3**—Set the paper feed and paper delivery systems. (The delivery system stacks the sheets after they are printed.)

**Step 4**—Fill and set the ink fountain for a smooth and even flow.

**Step 5**—Prepare the moistening solution and place the storage bottle on the press. Predampen the rollers and set the speed.

**Step 6**—Mount the plate and dampen it, following instructions.

**Step 7**—Follow these operational steps.

1. Turn on the press.
2. Apply moisture to the plate.
3. Apply ink. Adjust the flow of moistening solution and ink.
4. Set the paper feed. Turn on the paper feed. Complete the run.

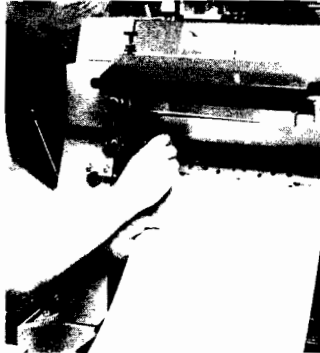

**Mount the plate on the press.**



**Adjust the flow of moistening solution and ink.**

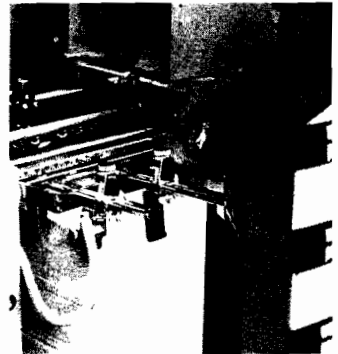

**Set the paper feed.**



**Operate the offset press.**



**Complete the press run.**

Check the first copies for correct margins, even ink coverage, and squareness. Make adjustments and print the required number of good-quality copies.

On certain presses, some of these steps may be combined with a single-lever operation. To stop, reverse the steps.

When your printing job is complete, clean the press and put everything in order, with cleaning rags in a safety can. Preserve the plate with gum arabic.



**Offset presses like these are used in many schools and small print shops.**

## Screen Printing

Screen printing, which uses a *stencil* and a fine screen mesh, is one of the most versatile printing methods because it can be used to print on almost any substrate. Printers often use screen printing to print on items such as T-shirts, computer circuit boards, and other surfaces that cannot be run through typical printing presses.

The mesh screen, usually made of polyester fabric, is stretched over a wooden or metal frame. The frame is placed on top of the substrate being printed, and ink is placed in the frame, on top of the screen mesh. Then a wide flexible blade called a squeegee is dragged across the screen, pressing ink through the openings in the mesh wherever the stencil has openings in it. When the ink goes through the stencil, it leaves the stencil's image on the substrate.

## A Short History of Stencil Printing

Stencil printing is an ancient art. In one early form, people pierced patterns in leaves and painted through the openings to make a design. The Chinese and Egyptians cut stencils to print designs on fabric and walls.

The Japanese became highly skilled in stencil printing, using special waterproof paper so that dyes would not soak through. To support delicate pieces of the stencil, they glued a fine network of human hairs across the openings.

Eventually, stencil craft spread through western Europe and was used commercially in England and France to decorate furniture and wallpaper. By the 1870s, the French and Germans were experimenting with the idea of using a stencil with a screen of woven silk fabric. In 1907, Samuel Simon of Manchester, England, patented the method. He stretched the fabric in the frame, attached a stencil to the screen, printed through the silk and stencil, and then removed the stencil.

The silk-screen process developed into a commercial printing process in the United States during World War I. It was used to decorate flags, pennants, and banners. In 1929, a new stencil material, a knife-cut film tissue, was introduced. This gave smoother edges to stencils.



## Today's Technology

**New Fabrics.** Silk was the primary screen fabric for many years, but it has been almost completely replaced in commercial printing by polyester and stainless-steel mesh. These materials provide greater strength, more uniform thread diameter, and a variety of mesh types. They are also easier to reuse, so they are more economical.

**New Stencil Materials.** The stencil material has also improved. Direct and indirect photographic stencil materials enable the screen printer to reproduce designs of greater detail and intricacy. For *direct stencils*, the stencil material is attached to the screen before the image is exposed onto the stencil. For *indirect stencils*, the image is exposed or cut into the stencil material before the stencil material is attached to the fabric.

**New Presses.** Electronic circuit boards provide a great example of how much detail can be reproduced with screen printing. The board starts out with a uniform coating of electrical conducting material. The pattern of the circuitry is then screen printed with an ink called *acid-resist*. The board is then dipped in acid, which eats away the conducting coating wherever it is not covered with the screen-printed acid-resist. When the resist is removed, the conducting circuit pattern is left on the board. Then the electronic components are applied. Screen printing also is used to print watch faces, automotive gauges, industrial instrument panels, T-shirts, and other clothing. Automated presses have sped up the screen-printing process. Large, multicolor screen-printing presses enable printers to produce colorful billboard advertisements.

**Screen printing works well on a variety of substrates.**

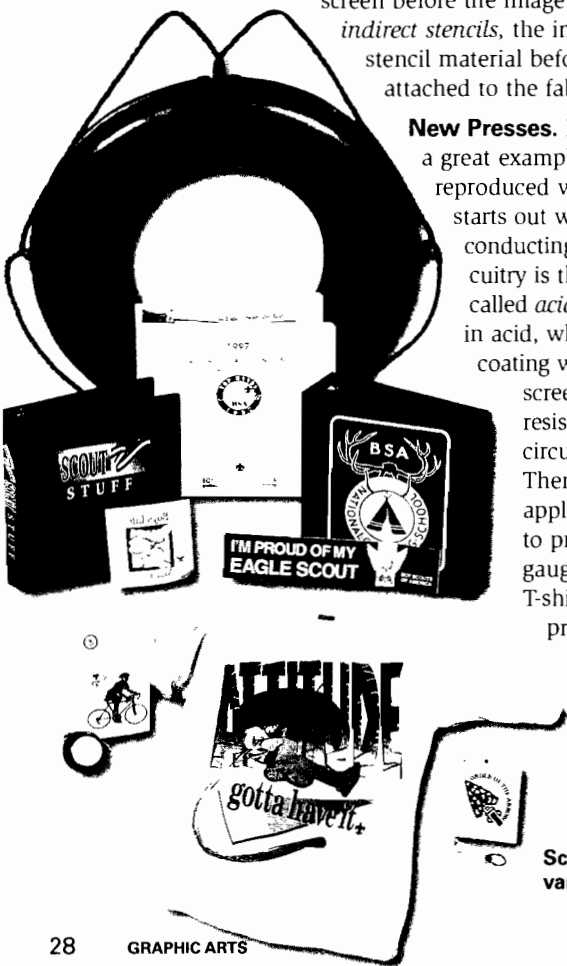

**Inks and Versatility.** Screen printing is used wherever a thick, brilliant film of ink is required. Outdoor signs, bumper stickers, and decals rely on screen printing for their rich color and durability. The versatility of today's screen printing owes a great deal to the variety of inks that can be printed through a screen.

**Printing Surfaces.** Screen printers can print successfully on paper, metal, wood, many kinds of plastics, glass, ceramics, cloth, and card stock—almost any material. The process makes printing possible on substrates of different shapes and sizes. Screen printing is the primary method used to print on oddly shaped bottles, jars, and other product containers.

Screen-printed textiles are a major business, and custom-printed T-shirts are a popular form of advertising, promotion, and sales. Today's T-shirt screen printer can print almost any kind of design, ranging from simple single-color logos and symbols to elaborate designs using a rainbow of colors and a variety of ink types.

### **The Process**

**The Design.** The printing process begins with a design. You will adapt your design to work with the type of stencil, ink, and substrate you plan to use.

Screen printing works best when your design is made up of large or moderately sized detail, and the ink is applied in a thick, uniform film. Designs with many fine lines, small detail, and a lot of type are not recommended for screen printing.

---

Check with your counselor ahead of time to find out what kinds of materials and equipment will be available for you to use.

---



**SCOUTING  
ROCKS!**

---

Plan a simple, single-color design to print on a poster, card, or perhaps a T-shirt. (But keep in mind the quantity requirement 4 asks you to print.)



**The Stencil.** Photographic stencils are the most commonly used stencils today. They require a positive image original, which will be placed in direct contact with a light-sensitized stencil material and then exposed. The positive image original can be produced using a graphic arts process camera or a high-quality photocopy machine that can copy onto translucent vellum or clear transparency film.

**The Ink.** A water-based air-drying ink is the easiest to use. Your counselor can help you select the right type of ink for the material you will be printing on.

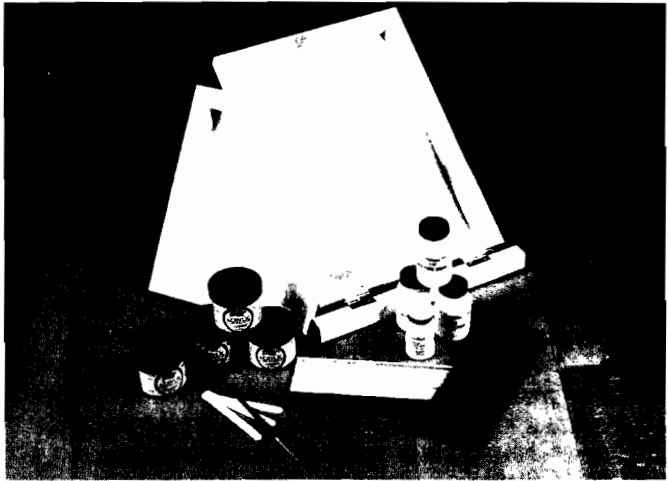

Many hobby and craft stores sell screen printing kits for items such as cards, posters, and T-shirts. Ask your counselor whether a kit is available and suitable for your project.

## Preparing the Stencil and Screen

The most common type of screen-printing stencil used today is the direct emulsion stencil.

**Step 1**—The usual method to make a direct emulsion stencil is to apply a uniform film of diazo compound (a light-sensitive emulsion) using a special scoop-coater or a stiff-bladed squeegee. Follow the manufacturer's instructions for preparing and coating your screen.

**Step 2**—Allow the emulsion to dry on the screen in the dark. Once dried, it will be sensitive to light. The bottom of the sensitized screen is placed in contact with the film positive image of your design. This may be done in a special vacuum exposure frame. You also may use a simpler method. Place a flat piece of sponge foam inside the screen frame and position the screen bottom-side up. Place the positive on the screen's stencil and a large sheet of glass on top. The foam inside the screen frame holds the screen in contact with the positive and the glass.

**Step 3**—Expose the screen's stencil to a light source that has a lot of ultraviolet light. Consult the manufacturer's recommendations about exposure times. Remember, high-intensity ultraviolet light can damage your eyes if you look directly at it, so find out whether precautions are necessary for the equipment you use. Newer equipment has safety features. You also may use natural sunlight to expose your screen.

**Step 4**—Wash out the image area. With most direct emulsions, you can easily wash out the design with warm water. When all image areas are free of unwanted stencil material, blot the screen dry with paper towels.

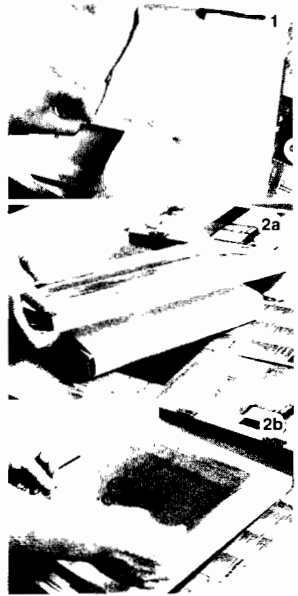

3



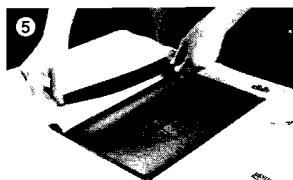

**Step 5**—Use gummied kraft paper packing tape to seal the inside of the frame. Cut four pieces of tape—two pieces the length of the top and bottom and two for the sides. Fold them, glue side out, and adhere them to both the frame and the mesh. This prevents ink from seeping between the mesh and the frame.



**Step 6**—Turn the frame over and seal all the open areas between the frame and the stencil. Use a special screen blockout fluid or masking tape to cover these open areas.

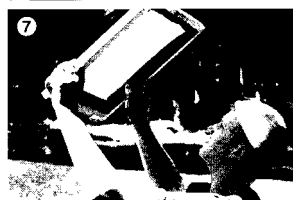

**Step 7**—Check your screen carefully by holding it up to the light and looking through it. Make sure all unwanted pinholes and defects are covered up.

## The Hand-Cut Stencil

If you are planning to make a hand-cut stencil, it is a good idea to use a water-adhering stencil film when you are starting out. It is easier and safer to use than the lacquer stencil film.

Keep your design as simple as possible. Use bold, simple shapes and simple block letters. Avoid fine lines and fancy script letters that are difficult to cut out. To make the simplest hand-cut stencil, cut a design in kraft paper or butcher paper. Ask your counselor about the steps in this process.

Place the stencil over the substrate and lower the screen. After you make the first pass with the ink, the stencil should stick to the bottom of the screen when it is raised. This type of stencil may not last as long as a stencil cut from film.

You may want to paint a design directly on the screen. Brush on the design with a water-soluble solution and mask it with a non-water-soluble solution. Then wash the design out, leaving the openings in the stencil for printing. Seal the edges and pinholes as described above. If you use this method, ask your counselor about appropriate solutions for painting the design and masking.



## PREPARING TO SCREEN PRINT

To set up your printing work area, do the following.

**Step 1**—Choose an area that is free of clutter and provides enough room for you to work without crowding. Lay down some newspapers to keep the work table clean, and get your tools and equipment together. You will need the following materials: a screen frame and *printing board*, an ink spatula, a squeegee, and a substrate.

**Step 2**—Prepare an area to place your printed pieces for drying. If you are working in a print shop or classroom, you may find special drying racks. You also can string a clothesline and use clothespins to hold your prints while they dry.

**Step 3**—Prepare to print. Attach the screen to the printing board. (The printing board will be under the screen when you print.) Locate the position of the image on the printing board. Use strips of card stock and adhesive tape to locate at least three *register stops* for aligning the image in the correct position on the substrate. *Registering* means having the printed image in the same place on each piece.

If you are printing on T-shirts, spray tacky adhesive on the printing board to hold the shirt in place. For printing with multiple colors, adhesive also helps register each color in the proper place in the design.

---

A *printing board* is a piece of wood about 3 inches wider all around than your screen. Attach it with hinges to one end of your frame. For a smoother printing surface, tape poster board or untextured mat board over the wood.

---



## PRINTING

Here are the steps for printing.

**Step 1**—Stir the ink thoroughly. Use the ink spatula to put a sufficient amount of ink at the top of the screen frame, not on the open parts of your stencil. Spread it to the width of your design so that when you make your first print, all areas will be covered.

**Step 2**—Use both hands to hold the squeegee. Hold the squeegee almost upright, at an angle of about 75 to 80 degrees, at the top of the screen frame. Applying even pressure, pull the squeegee toward you slowly and evenly to force the ink through the screen and onto your substrate.

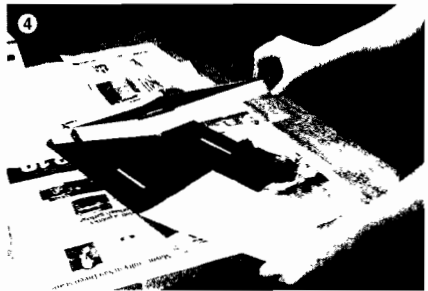

**Step 3**—After completing the print stroke, lift the screen frame off the surface and return the squeegee to the top of the frame, using a flood stroke to spread a thin film of ink and prevent the screen from drying out and blocking fresh ink. (Some screens have a leg to hold the frame up between prints, or you can prop it with a small block of wood.)

**Step 4**—Carefully remove your printed piece and put it in the drying area.

**Step 5**—Repeat the process until you have printed the required number of pieces.



## CLEANING UP

Use the correct type of solvent for the ink you are using. Water-based and acrylic inks are recommended because they wash up with water. Oil-based flat colors and plastisol textile inks must be cleaned up with mineral spirits or paint thinner.

Some screen inks and solvents can be hazardous if used incorrectly. Check with your counselor for instruction about proper handling and ventilation requirements. Also ask whether you should wear protective gloves for cleanup and about the proper disposal methods for any hazardous waste products.





Use absorbent cloth rags or special paper towels to clean all equipment. Your counselor will guide you in specific cleanup procedures and the proper disposal of any solvents and solvent-soaked rags or cloths.

After cleaning the ink from the screen, remove the paper tape and blockout fluid with warm water. Remove the stencil, following the manufacturer's instructions. You can remove some stencils with ordinary warm water, but others require special chemicals and/or high-pressure water washout.

## Gravure Printing

Gravure printing (also called rotogravure) is considered the finest method of reproducing pictures. However, the high cost of making the printing plates usually limits its use to long press runs. High-quality magazines, Sunday newspaper magazine sections and color advertising fliers, large mail-order catalogs, postage stamps, currency, and expensive books usually are printed using gravure. Other products well-suited to gravure printing include wall and floor coverings, plastic laminates used for cabinets and countertops, and patterned vinyl surface coverings used in the furniture and automotive industries. Many packaging materials also are printed by gravure.



**Gravure printing press**



**Etched gravure cylinder**

Gravure printing uses a recessed (sunken) surface shaped like the image to be printed. The image to be printed is carried in tiny cells (or wells) that are chemically etched or engraved below the surface of the image carrier. The entire surface of the image carrier is flooded with a thin, liquid ink. Then the surface of the image carrier is wiped clean by a flexible steel *doctor blade*, leaving ink in only the tiny cells. The ink is transferred to the surface to be printed when that surface is tightly pressed against the image carrier.

In gravure, as in other processes, the layout is either photographed or electronically captured as a computer file. Several different methods are used to transfer the image to the printing image carrier, or cylinder. Conventional gravure processes use continuous-tone film images and photographically sensitized coatings to place an image on the surface of a gravure cylinder. More modern technology uses mechanical or laser engraving techniques to etch the cylinder to make the recessed cells.

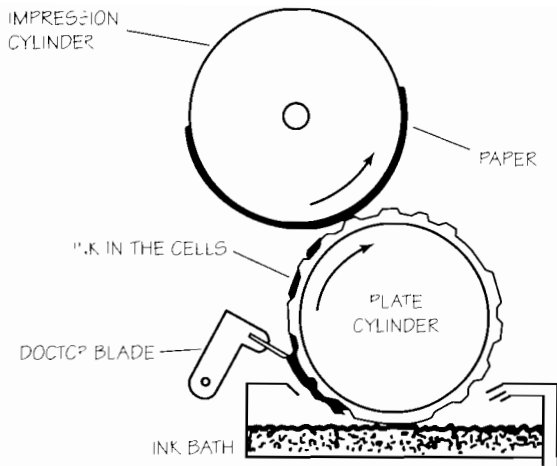

**Diagram of a gravure press**

There are some variations among image carriers for the gravure process. The image carrier may be an etched, copper-coated steel cylinder, or a wraparound plate, or sometimes even a flat plate like those used in manual printing processes.

Gravure presses are single-color or multicolor. Unlike other printing processes, all portions of the gravure image, both line and continuous tone, must be converted into tiny dots. Ask your counselor to show you some samples of gravure printing or ask to visit a gravure printing shop to see the actual printing process in operation.

## Electronic/Digital Printing

The most recently developed printing processes rely on computers. The computers process digital information that is input from scanners or digital cameras, photo compact discs (CDs), the Internet, and a wide variety of other image-gathering and image-storage devices. All this digital image information can be manipulated in the computer in ways that have never been available before.

*Electrostatic printing, or xerography,* uses reflected light from an image on an original to apply electrical charges to the substrate being printed. *Toner,* a powdered ink, has an opposite electrical charge. The charged area of the substrate attracts the toner. Then the substrate passes through a *fuser* that melts the toner in place on the substrate.

*Laser printing* works much like the electrostatic process, but it does not use reflected light. Instead, a laser receives instructions from a computer and places the charge on the substrate. The toner-covered substrate passes through a fuser to finish the process.

*Ink-jet printing* uses a series of microscopic sprayer nozzles that squirt droplets or bubbles of ink onto the paper. A computer “instructs” the nozzles to spray only where the image is to appear. Ink-jet printers may be as small as a desktop computer printer or a digital photo printer. They can also be more than 15 feet wide and capable of producing billboards.

*Digital duplicators* are highly automated machines designed to print on paper. The image to be printed is sent from a computer to the duplicator, which makes a high-quality stencil. The stencil is wrapped around a fine wire mesh cylinder. Ink is then forced from the inside of the cylinder, through the open areas of the stencil, and onto the paper. The basic idea of using a stencil and a mesh is like screen printing.

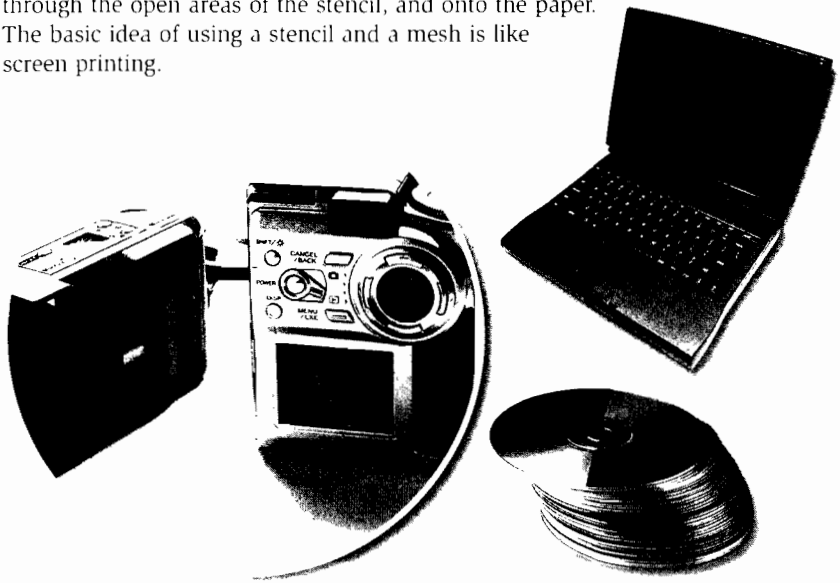

**Digital cameras and computer systems have helped make complex photographic operations quick and easy.**

## Output Devices

Output devices attached to these computers can produce anything from a single black-and-white copy to large quantities of full-color copies. Choosing the best output device depends primarily on three factors: the quantity of copies needed, the quality desired, and the amount and variety of color to be printed.

- Single copies and small quantities printed with one or more colors are generally made on desktop laser printers and ink-jet printers.
- Medium quantities can be printed one color at a time on digital duplicators.
- Large quantities can be printed quickly on toner-based digital presses and high-speed laser printers.
- Larger quantities of single-color work are usually printed using other processes, such as offset lithography.

Color printing in most processes is complicated and expensive. The more expensive the setup, the more pieces you have to run to make the job cost-effective. If you choose an expensive method for a small printing job, the cost per printed piece may be too great.

However, because of changes in technology, printers constantly reevaluate their choices of output devices. On one hand, developments in digital presses and high-speed laser printers allow these machines to print more quickly and handle larger quantities. On the other hand, the cost of offset printing is decreasing because of digital platemaking. Now printing large quantities is not required to reduce the cost of each printed piece.

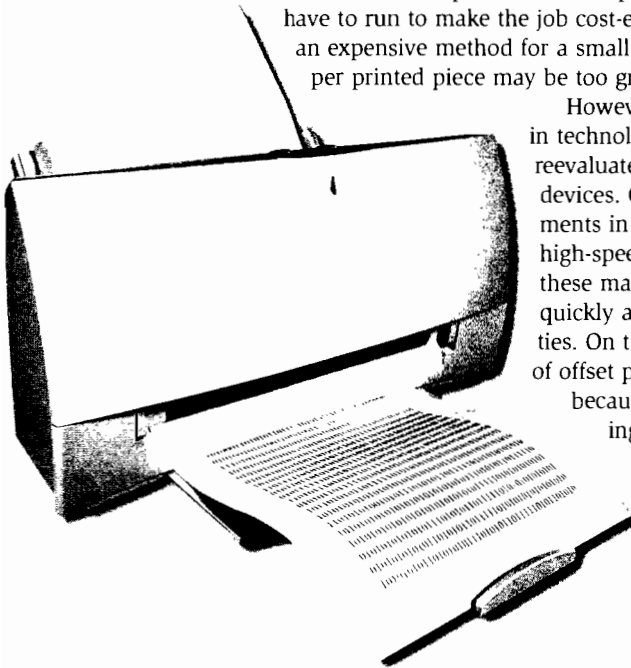



## Resolution

When preparing your layout on the computer, you must consider the *resolution* of your output device. The resolution is a measure of the clarity and detail the output device can show, which affects the quality of the image in the layout. The unit of measurement for resolution is *pixels per inch (ppi)*. A *pixel* is the smallest mark, or picture element, the output device is capable of creating. The higher the ppi number, the better the resolution and the better the output will look.

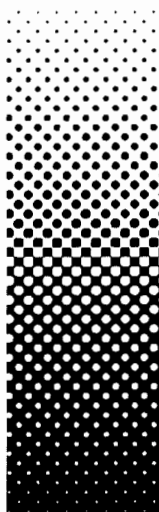

**Traditional halftone**



**Stochastic halftone**

Pixels are grouped together to make line art and text. Laser printers produce traditional halftones by converting groups of pixels into large or small regularly spaced dots, arranged in a grid. Ink-jet printers produce *stochastic halftones* by converting groups of pixels into same-size dots, arranged in a random way to imitate a continuous-tone image.

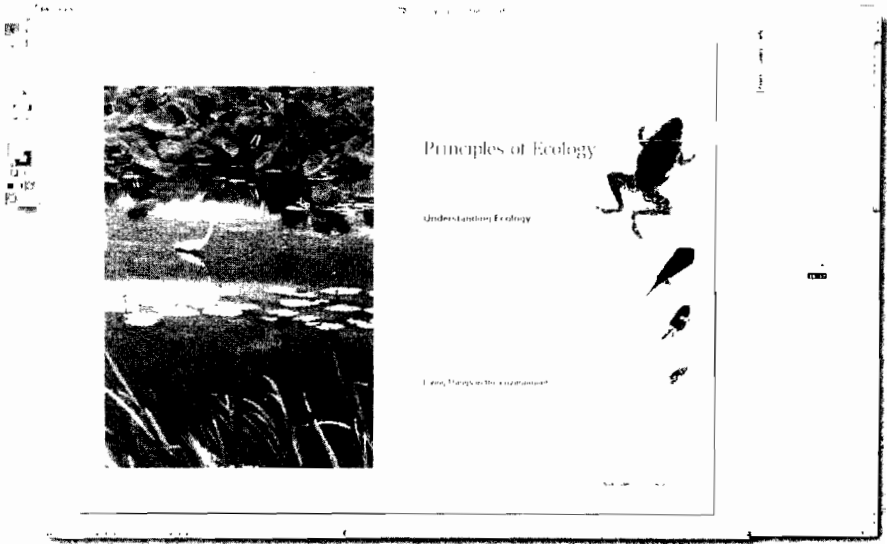

**Graphic designers today produce layouts in electronic form.**

---

A *resident font* in an output device, such as a laser printer, is a font that is included in the software that is a permanent part of the output device.

---

## **Layouts**

In electronic/digital printing, you create your layout in digital form using desktop-publishing software. The result is a layout of the design in electronic form. Specifics for preparing the layout will vary with the software used, but here are a few general guidelines.

- If you use a scanner to input line art, the resolution of the scan does not need to be any greater than the resolution of the output device.
- Any vector versions of the fonts you use in your design should be available in your output device as *resident fonts*, or the fonts should be in your computer system so they can be downloaded to the output device.
- For scanning continuous-tone images, the rule of thumb is that the resolution of the scan should be twice as much as the desired line ruling (dots per inch) in the halftone you will print.

Always be sure the file being sent in the download has no errors. Otherwise, you will waste paper by printing incorrect sheets.

## Printing

When the layout in electronic form is finished, you send it to the output device for printing. This is called downloading the layout. Depending on what equipment is available and suitable for your project, you might be downloading your layout to a high-speed laser printer, a digital press, or a digital duplicator.

When you download your layout to a digital duplicator, a master is made and a sample, or *test print*, is printed. If the sample is acceptable, you select the quantity on the duplicator's control panel, and then the duplicator prints the correct number. In some systems, you choose the quantity when the file is downloaded.

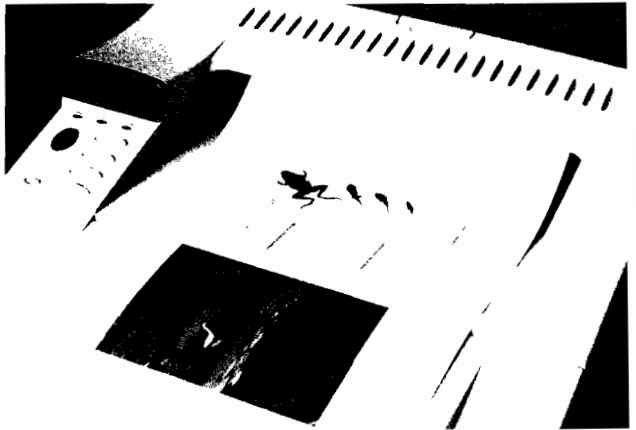

Modern laser printers are capable of creating highly detailed images at fast speeds.



High-tech copiers can accept electronic files for output.

# Preparing to Print

Every printing job requires planning. First, the printer has to understand what type of job it is and what the finished piece is expected to be. Then the printer decides which printing process is best for the job. At that point, each step can be planned to prepare the job for printing.

Some printing processes are better suited than others in terms of speed and/or quality for a particular project. With so many new technologies and options available to printers today, planning is very important. At the start of your printing project, you will decide which process to use so you can make the correct preparations.

The beginning of a printing job can be broken into two parts: the *design* and the *layout*. The design portion deals with deciding how you will communicate your message and what that message will look like. For example, if you want to promote an event, you need to decide whether it would be better to design a flier, a brochure, a poster, or a T-shirt for printing. You will also decide what kind of *design elements* you want to use. Design elements are the words and pictures of your design. Printers usually refer to the words as *text* and the pictures as *graphics*.

When you are ready to do the layout portion, you assemble all the elements of your design to make a *master*, a completed version that will be the basis of what you will be printing. The printing process you plan to use and the equipment you have available will determine the way you assemble your layout.

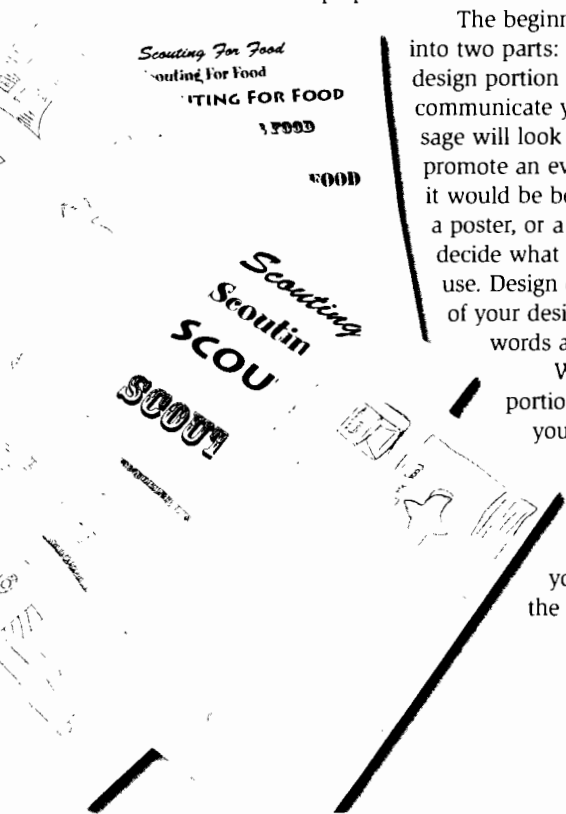

## The Design Process

### Step 1—The Thumbnail

When you are developing a design, think of a lot of different ways to do it. Sometimes your first idea will be a good one. Sometimes a better idea will come along later.

Your first step is to make *thumbnail sketches*. Your thumbnail sketch will be a simple pencil drawing of your design idea, usually smaller than the size you plan for the printed piece. It mainly shows proportion and the shape of the piece, with the design elements drawn as basic geometric shapes (lines, circles, rectangles, etc.). You can make small thumbnails rather quickly, moving the design elements around.

You should make more than one thumbnail sketch. It is a good way to think and change your mind, moving from one design to the next and inventing different ideas. One idea will lead to another. You will have several ideas to choose from, and this will help you create the best possible design.

---

The term *thumbnail* comes from the tradition of early letterpress printers who used their thumbnails to mark a soft clay or wax tablet with their preliminary design plans.

---

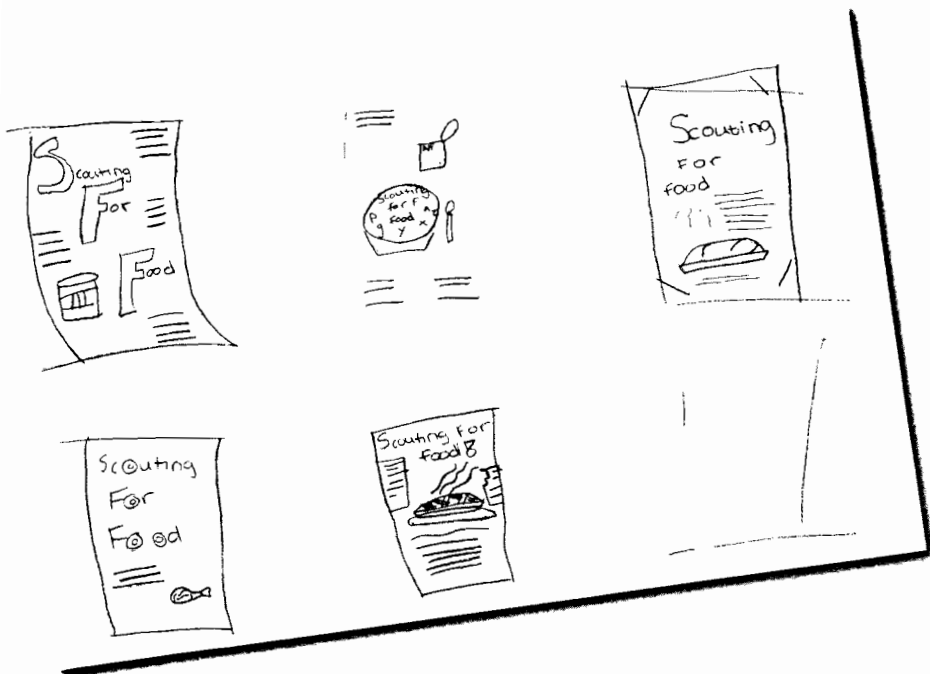

## Step 2—The Rough

The next step is to choose your favorite thumbnail and expand on that design. This expansion of the thumbnail is called a *rough*. A rough is drawn the actual size of the planned piece, and it shows the design elements in greater detail than the thumbnail did. The rough will serve as a guide to describe the specifics of the design to others who may be assisting in the production of the job.

- Draw the larger words, as best as you can draw them, in the style and size they will be in the printed piece.
- Show long paragraphs as a series of straight lines.
- Pictures in the design should depict minimum details. For example, you can draw people as stick figures and objects in the picture as basic geometric shapes.

Write notes off to the side of the rough to indicate the sizes and styles of the type and the picture's format and source. Write these notes in a color different from the color you used for design elements. This will make it easier to tell the difference between the design elements and the notes that describe them. (You may omit these notes if you plan to make a comprehensive. See step 3.)

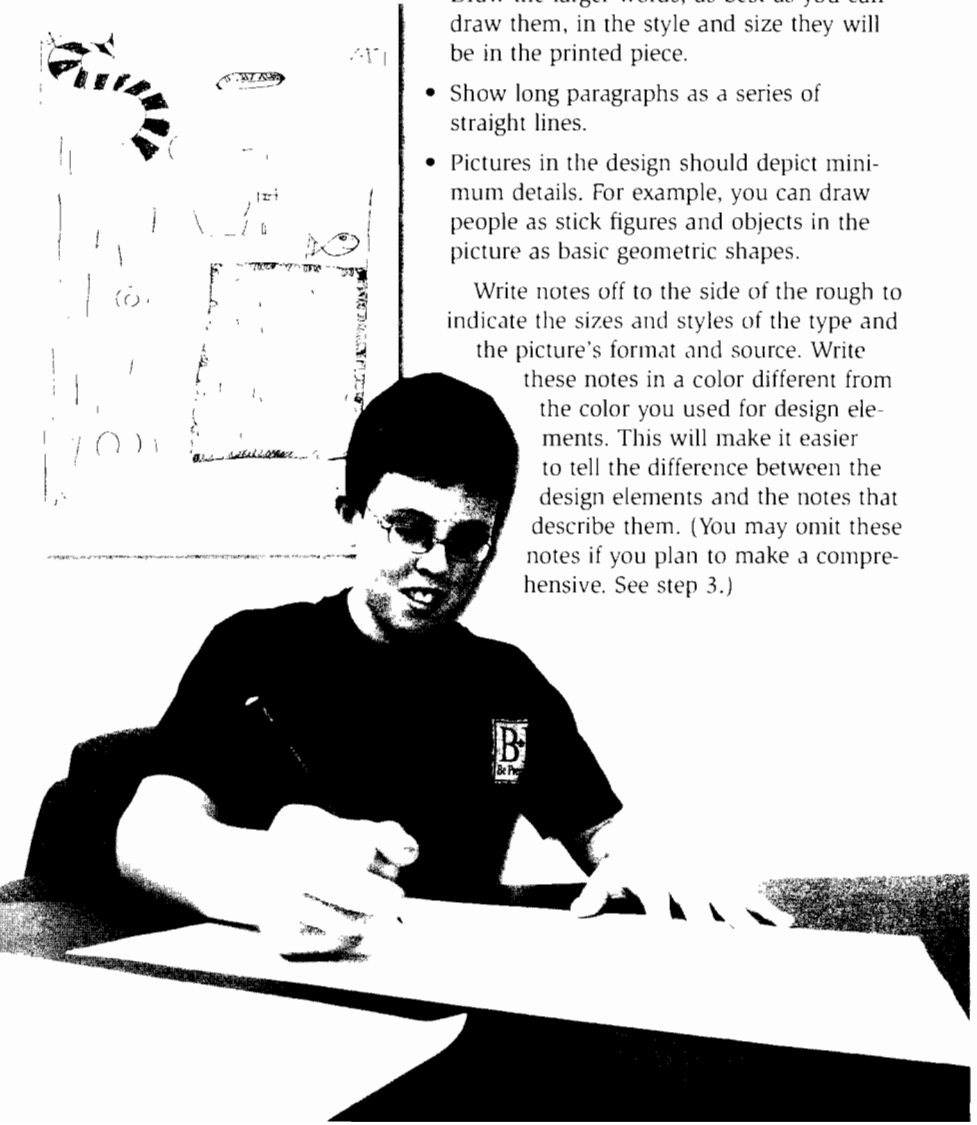

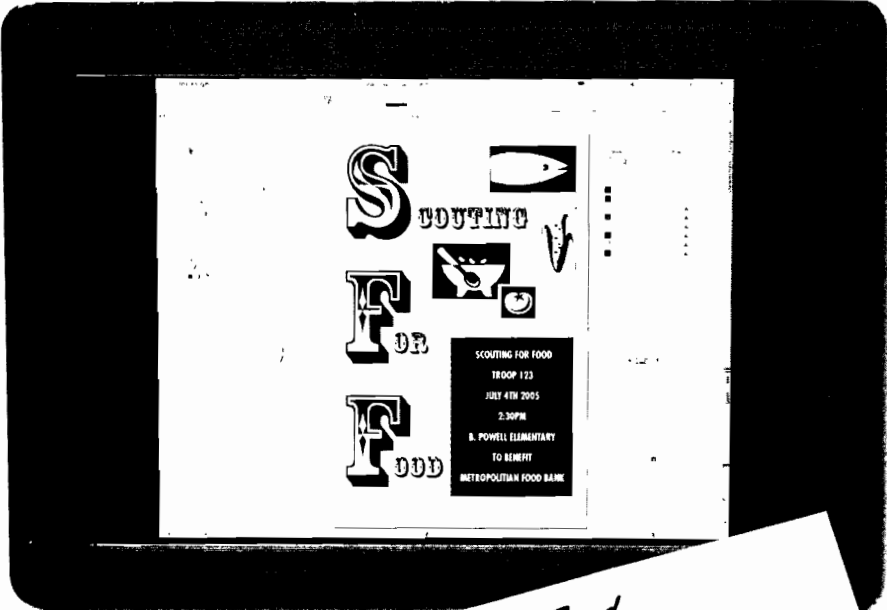

The comprehensive looks pretty close to what the finished product will be.

### Step 3—The Comprehensive

Sometimes there is a third step, called a *comprehensive*, or *comp*. A comp is a very detailed, hand-drawn representation of the way the final piece will look. A comp usually is made to show a customer or client. Some customers may not be able to interpret a rough, but a comprehensive will show them what the design idea will look like when it is printed. Add notes regarding type and pictures.

*Scouting For Food*  
*Scouting For Food*  
**SCOUTING FOR FOOD**  
**SCOUTING FOR FOOD**  
*Scouting For Food*  
**SCOUTING FOR FOOD**

## Text and Graphics

The design you create may contain both text and graphics. Your choice of text and graphics and the way you arrange them are important considerations. For example, choosing an easy-to-read typeface will help get your message across. On the other hand, including too many images in your design may detract from your overall message. Different text styles and graphics can even communicate moods or emotions that go beyond what the text says or what the graphics show.

### Roman:

GARAMOND *Caslon*  
CENTURY OLDSTYLE ITALIC  
BODONI GOUDY

---

### Sans serif:

FRANKLIN  
PUBLICITY GOTHIC  
UNIVERS 55 Avant Garde

---

### Text:

Goudy Text Old English

---

### Script:

*Berthold Script* *Freestyle Script*  
*Brush* *Sinclair Roundhand*  
*Medici Script* *Troutbeck*

---

### Novelty:

*Cabaret* BALLOON BOLD  
Branding Iron BROADWAY  
PARIS FLASH

### Type Classifications

Text can be organized into five different type classifications: roman, sans serif, text, script, and novelty.

*Roman* type has both heavy and light letter strokes ending with *serifs*. Serifs are fine lines that are drawn at the end of a main letter stroke. They help a reader group together the individual letters in a word. This makes it easier for a reader to see the whole word and to follow a line of text across the page.

*Sans serif* type is roman type that does not have serifs. The characters often are described as being plain or block letters.

*Text* type, frequently described as Old English in design, looks like the *calligraphy* style of writing used in the illuminated manuscripts of the Middle Ages.

**Calligraphy is the art of producing artistic and elegant handwriting or lettering.**

*Script* type is designed to look like cursive handwriting. It often looks as though the letters in each word are connected.

*Novelty* type does not fit neatly into any of the above descriptions. It may have some characteristics of other classifications or no resemblance to them. Novelty type is unique and is sometimes called decorative type.



Within each type classification, there are different versions called *type families*. For example, the type family called Palatino is in the roman type classification. The Palatino family includes different family “members,” or *type styles*, such as Palatino condensed, Palatino expanded, **Palatino bold**, *Palatino italic*, and other styles.

Traditionally, in letterpress printing, the term *font* was a style of type from a particular family at a specific size, and each font was usually stored in its own storage box called a job case. Today, with type being stored digitally on computers, a font generally refers to a particular type family (such as Palatino) of a certain style (such as italic), with all sizes available within the digital information that describes the font to the computer.

The size of type is measured in units called *points*. A point is  $\frac{1}{72}$  of an inch. A typical point size for text in a book is 10 points. This type you are now reading is 10 points. Another unit of measurement in printing is the pica (pronounced PIE-ka). A pica is equal to  $\frac{1}{6}$  of an inch. That means there are 12 points to a pica and 6 picas in an inch. Picas are usually used to measure the size of a column of type or occasionally the size of a layout.

Sometimes, especially when printing jobs contain a lot of text (such as books, magazines, or newspapers), a person called a typesetter sets the type and outputs it (prints it out or provides it via computer).

This first output is sometimes called a *galley proof*. A *proofreader* reads the proof and looks for errors, marking any mistakes with proofreader’s marks. The typesetter then makes the corrections. When the job moves on to the next step in the production process, it should be free of typesetting errors.

---

The term *galley* comes from the name for the tray that held the first draft of handset type in letterpress printing.

---

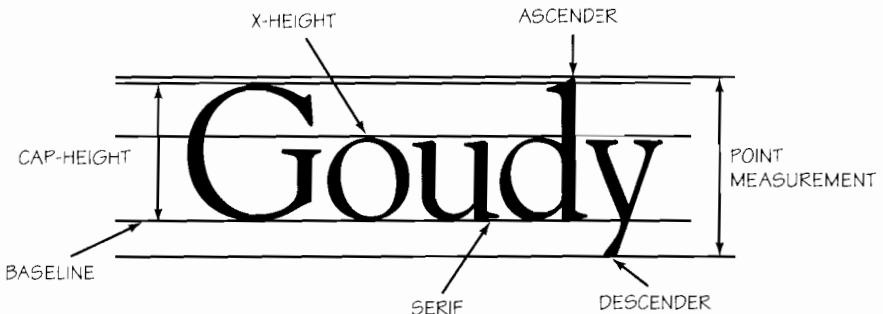

**Parts of type**

#### Type family

Garamond Light

Garamond Book

**Garamond Bold**

**Garamond Ultra**

*Garamond Light Italic*

*Garamond Book Italic*

***Garamond Bold Italic***

***Garamond Ultra Italic***

Garamond Light Condensed

Garamond Book Condensed

**Garamond Bold Condensed**

**Garamond Ultra Condensed**

*Garamond Light Condensed Italic*

*Garamond Book Condensed Italic*

***Garamond Bold Condensed Italic***

***Garamond Ultra Condensed Italic***

#### Different point sizes

This is an example of 6 point Helvetica type

This is an example of 10 point Helvetica type.

This is an example of 12 point Helvetica type.

This is an example of 18 point  
Helvetica type.

This is an exam-  
ple of 36 point  
Helvetica type.

✓ APOSTROPHE

\* ASTERISK

≡ CAPITALIZE

^ CARET; INSERT

) CLOSE UP

:

∩ COMMA

⌫ DELETE

— EM DASH

— EN DASH

! EXCLAMATION POINT

⊗ FIX BROKEN TYPE

= HYPHEN

lc LOWERCASE; SMALL LETTERS

¶ NEW PARAGRAPH

(/ ) PARENTHESIS

⊙ PERIOD

? QUESTION MARK

“ ” QUOTATION MARKS

; SEMICOLON

# SPACE

sp SPELL OUT

.... STRET; LET IT STAND

↻ TRANSPOSE

⊙ TURN A REVERSED LETTER

wf WRONG FONT

Reader's marks

For these:	Mark the margin and the copy as follows:	To change to this:
Lower case <i>lc</i>	<u>ON MY HONOR</u>	On my honor
Caps <i>Caps</i>	<u><u>on my honor</u></u>	ON MY HONOR
Roman <i>rom</i>	<i>On my honor</i>	On my honor
Italic <i>ital</i>	<u><i>On my honor</i></u>	<i>On my honor</i>
Let it stand <i>stet</i>	On my <del>honor</del>	On my honor
Insert <i>my</i>	On <sup>^</sup> honor	On my honor
Transpose <i>tr</i>	On [honor] [my]	On my honor
Align Type =	On my h <u>o</u> nor	On my honor
Close up <i>C</i>	On my ho <u>n</u> or	On my honor
Space #	On <sup>#</sup> my honor	On my honor
Paragraph ¶	<u>On my honor I will do my best to do my duty to God and . . .</u>	On my honor I will do my best to do my duty to God and . . .
Move right ]	On my honor I will do my best <u>to</u> do my duty to God and . . .	On my honor I will do my best to do my duty to God and . . .
Move left [	On my honor I will do my best <u>[</u> to do my duty to God and . . .	On my honor I will do my best to do my duty to God and . . .
Center ] [	] <u>THE SCOUT OATH</u> [ On my honor I will do my best	THE SCOUT OATH On my honor I will do my best
Break line Z	On my honor I will do <u>]my best</u> <u>to do my duty to God and . . .</u>	On my honor I will do my best to do my duty . . .

### Examples of proofreader's marks

## THE SCOUT OATH

A

On my honor I will do my best  
to do my Duty to God and mycountry  
and to obey the Scout Law;  
to help other people at all times  
to keep myself physically strong,  
mentally awake, and morally straight.

THE SCOUT OATH

On my honor I will do my best  
to do my Duty to God and mycountry  
and to obey the Scout Law;  
to help other people at all times ;  
to keep myself physically strong,  
mentally awake, and morally straight.

Center  
All  
Type

## THE SCOUT OATH

C

On my honor I will do my best  
To do my duty to God and my country  
and to obey the Scout Law;  
To help other people at all times;  
To keep myself physically strong,  
mentally awake, and morally straight.

The initial proof is shown in figure A. The corrected, final proof—ready for pasteup—is shown in figure C. Note how the corrections marked in the marked-up proof in figure B affect figure C. Then compare figures A and C.

## Graphics

The word *graphics* means the artwork used in printing. There are three categories of graphics: line art, continuous-tone images, and halftones.

*Line art* is made up of lines, solid areas, and sometimes small dots. Although it does not have real shades of gray as continuous-tone images do, shades of gray can be imitated with fine lines called cross-hatching or small irregularly spaced dots called stippling.

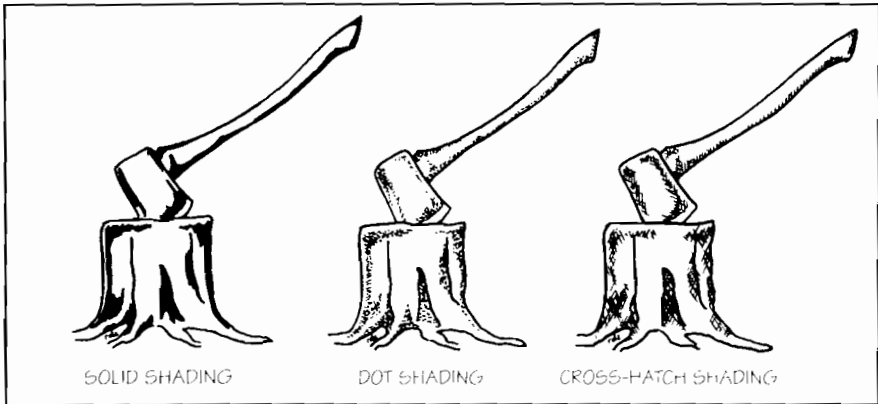

**These examples show the different types of shading in line art.**

A *continuous-tone image* contains shades of tone or color like a smudge of charcoal or a rainbow. Examples of continuous-tone images are photographs from a camera, pencil drawings that contain various shades of gray, watercolor or oil paintings, or any image that has ranges of color and/or tone that are *not* represented by dots or lines.

Continuous-tone images cannot be reproduced exactly using traditional printing processes, although some of the newer electronic/digital processes can make very close imitations. The process used to print this book cannot make a close imitation of continuous-tone images, so an example cannot be included. Continuous-tone images must be converted to halftones to be reproduced by printing processes.

Halftones are used to print images that look like continuous-tone images. A *halftone* is a series of regularly spaced dots of different sizes. The dots create an optical illusion that tricks the

eye into thinking it sees a continuous-tone image. The number of halftone *dots per inch* (sometimes called *spots per inch*) usually ranges from 85 to 300. Most of the halftones in this book are 300 dots per inch, or DPI.

The dots are so small, the human eye cannot see the individual dots unless they are magnified, but the eye does see an overall effect that imitates continuous tones. The arrangement of the dots creates this effect. The dots in the part of a halftone image that is supposed to look dark are big and fill most of the dot area. The dots in the part of a halftone image that is supposed to look light are small and fill very little of the dot area.

Generally, halftones are made from a continuous-tone image, such as a photograph. Traditionally, the continuous-tone image was photographed through a special screen that created a halftone version of the original. Today it is more common to take a continuous-tone image and scan it into a computer. The computer software converts it into a pattern of small dots that make up a halftone.

The line art and halftones you see in printed pieces may have started out as photographs, pen-and-ink drawings, paintings, or other traditional artwork. Today, some of these printed graphic images may have been created on a computer.

All artwork—traditional art or computer art—needs to be converted into a format that allows it to be printed. In the past, these conversions involved some kind of photographic process, but computer systems are now the primary way of making these conversions. Computers can convert either traditional or computer artwork into digital information that is stored in the computer's memory and can be used to prepare the artwork for printing. The digital information is categorized as being either a bitmapped image or a vector image.

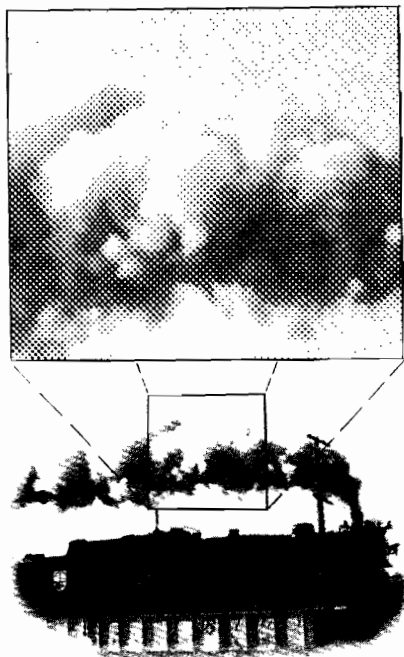

**This halftone shows an already-printed photo made up of dots of different sizes; the enlarged portion shows the dot structure.**





## Design Concepts

When you are designing your printed piece, it is important to choose the right text and graphics for your message. It is also important to arrange those choices in an appealing and efficient way that communicates your message effectively.



**Different typefaces exist for a reason.** Each type classification is generally suited for a particular purpose. For example:

- Roman type is usually used for books, newspapers, magazines, or any printing where there is a lot of continuous reading.
- Sans serif type is typically found in headlines, titles, and other display situations. This type is well-suited for use at very small sizes or for printing where you want to look at words letter by letter, as in a dictionary or a phone book.
- Text type has an “official” look and is often used for religious documents or other important documents, such as diplomas, certificates, and legal papers.
- Script type usually projects a sense of elegance and formality. It is commonly used for wedding invitations or where the appearance of ceremony or a carefully crafted human touch is desired.
- Novelty type may be designed to look powerful, silly, exciting, special, frantic, zany, or nearly any mood you want. Novelty type should be used sparingly.

You can communicate your message through your choice of type style, too. For example, *italic type adds emphasis*, and **bold type draws the reader's attention**.

Keep different type characteristics in mind and choose type to enrich the message in your design. However, be careful not to use too many typefaces in one design. Excessive typeface use, which is easy and tempting when setting type on a computer, can turn your design into something that ends up looking busy and disorderly, like a ransom note pieced together from words out of a magazine. In addition, avoid setting type in all capital letters—and never use “all caps” with script or text typefaces.

Your choice of graphics will be greatly affected by the layout techniques and printing processes available to you. If the graphic you want to use is the key to your design, that graphic may determine the printing process you have to use. Or sometimes the processes or equipment available to you will determine the graphics you can use.

You may be able to create your own artwork, or you may have artwork sources available to you. Before you finish your design, ask your merit badge counselor about possible artwork choices so you can come up with a workable and effective solution for your graphics.



The last step in finalizing your design is determining balance—how to arrange the text and graphics for maximum effect. Typically, design elements can be arranged either formally or informally. *Formal balance* is a design arrangement where the elements are placed about a center line and create a symmetric appearance. With *informal balance*, the design elements are arranged in a visually appealing way and are placed to draw attention to a particular design element or to invite the eye to flow along the page. The ultimate goal is to arrange the elements of your design in a way that communicates the message easily and effectively.

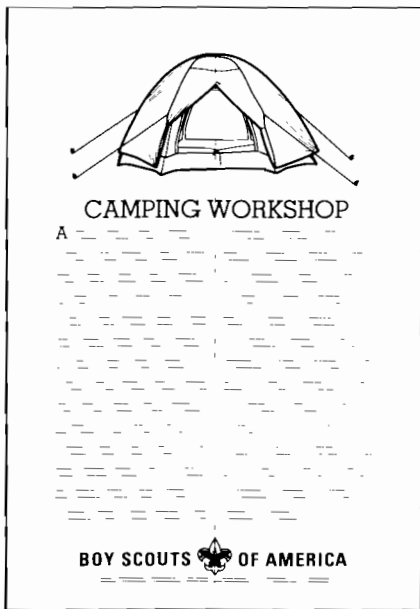

Formal balance

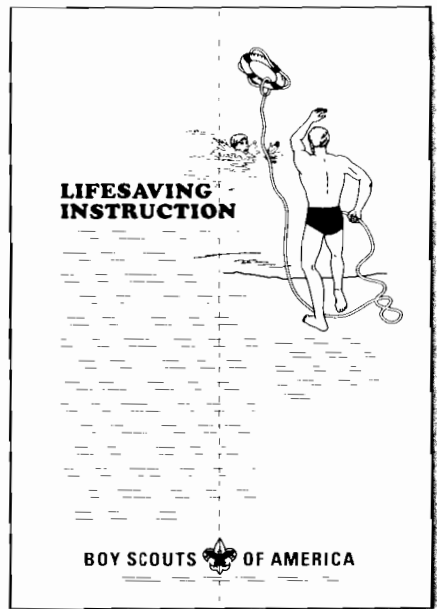

Informal balance



SCOUTING



SCOUTING FOR FOOD  
 TROOP 123  
 JULY 4TH 2005  
 2:30PM  
 B. POWELL ELEMENTARY  
 TO BENEFIT  
 METROPOLITIAN FOOD BANK

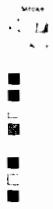

# Making the Layout

There are two ways to make a layout—the final version of the design you prepare for the printing process. One is to use a traditional method called a *pasteup*. The other is to lay out your design on a computer, using *desktop-publishing software*. Except for handset letterpress printing, every printing process discussed in this book starts with a layout made by one of these two methods. Your choice of a layout method depends on the equipment you have to work with and the printing process you plan to use.

Discuss your production plan with your merit badge counselor to make sure your plan will get your design to the press. Once you have made the layout, you will be ready to move on to the next step in the printing process you have chosen.

## Making a Traditional Pasteup

The traditional pasteup, sometimes called a *keyline*, is made on a piece of heavy white paper or illustration board. It is called a pasteup because you paste all the text and graphics on the board according to the rough design. The “paste” is usually either rubber cement or adhesive wax.

Make your pasteup as neatly and cleanly as possible, because any mistake on the pasteup has the potential to show up on all your printed copies. To make a pasteup neat and straight, use a drawing board, T-square, and other traditional layout tools. Pasteups are almost always made at the same size that the final printed piece will be.

You can type the text for your pasteup on a computer and print it out. The letters should be black and the paper should be white. You can also cut out appropriate text from other printed pieces, trace it, or write it by hand. Be careful not to use copyrighted material from printed sources.

You can draw your graphics by hand, using printed sources as a guide. Or you may be able to find *clip art*, which is pre-printed graphics for printers to clip out and add to their pasteups. (Computer clip art is another form of the same thing.) If you draw original graphics, use a black ink pen or marker.

When all the text and graphics are accurately fixed in position, the completed pasteup is called a *mechanical*, or *camera-ready copy*. The next step is to make a high-contrast negative. This negative can be used to make a plate for lithography or flexography, or it can be used to make the film positive that is needed to make a photographic stencil for screen printing.

After you shoot photographs and have your film developed, you get back both negatives and positives. In a *negative*, light areas are dark, and dark areas are light. When a negative is printed, you get a *positive*, which looks like the view you saw with your eyes when you took the picture.



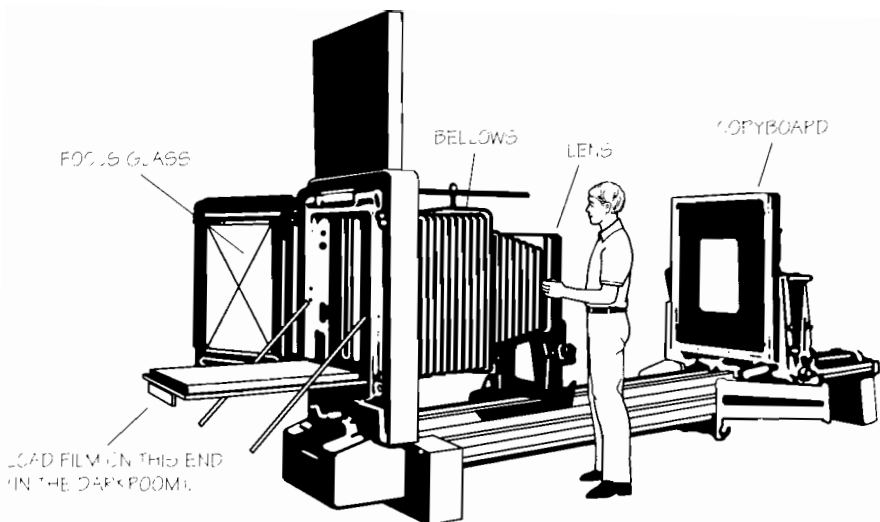

## Making the High-Contrast Negative

A high-contrast negative is made with a large *process camera*, which has a lens that is specifically designed to photograph flat copy (that is, without depth). In the floor-type horizontal process camera shown, the back of the camera where the film is loaded is actually built into a darkroom. Procedures may vary with different camera equipment, so you will need special instructions for the equipment you use. Below is the general procedure.

**Step 1**—Place the pasteup, or camera-ready copy, securely in the copyboard.

**Step 2**—Set the lens for the size of copy and the speed of shooting. Set the scales on the copyboard end and the bellows end of the camera to indicate any reduction or enlargement for your shot. (If the scales are not set the same, your shot will not focus correctly.)

**Step 3**—In the darkroom, you can see a projected image of the pasteup from the copyboard. Position this image on the focus glass. Set the back of the vacuum for the film size.

**Step 4**—Prepare the three trays of chemicals—developer, stop bath, and fix. (Stop bath is not always used.) Wear goggles and use tongs to protect your eyes and skin from the chemicals. Use a fourth tray for washing the film.

**Step 5**—Film can be exposed only under a *safelight*. (The safelight has a filter that screens out rays that can harm the light-sensitive film.) Make sure all film boxes are closed properly every time.

**Step 6**—Film has *emulsion* and base sides. (Emulsion is a gelatin or solution used as the light-sensitive coating on film.) Handle film on the edges only and avoid scratching the emulsion. Place the film on the vacuum back with the emulsion (or dull) side up on the vacuum back. Expose the film according to the manufacturer's instructions.

**Step 7**—Film development (in the first tray) is most important. The film has to develop to the right density for a sharp image. If you develop the film too long, it will be overdeveloped and too dark; if you do not develop it long enough, it will be underdeveloped and too light. Charts and scales for development times are available.

**Step 8**—After development, place the film briefly in the stop bath and then into the fix, following instructions. The film has to be in the fix for about 5 minutes before bright lights can be turned on in the darkroom. Wash the film in running water for the recommended time (usually about 5 minutes). Dry it, using the available method (hanging it out on a line or using blow dryers).



## Making Layouts Using Desktop-Publishing Software

Most layouts today are done on computer systems by using software applications to make text documents and graphics documents. It also is possible to take text and graphics made from different applications and put them together in another application to make a layout document. When layout artists use software applications to create documents, they save those documents in the computer memory as *files*.

Here are some of the tools you can use when using a computer to make a layout.

- Use word-processing software to set type for text.
- Create bitmapped or vector graphics with painting, drawing, or illustration software.
- Use computer clip art.
- *Scan* (electronically photograph) your own graphic creations, using a scanner hooked up to a computer. Do not scan copyrighted material for your project.



- *Download* (transfer) both text and graphics from the Internet. (Make sure you have your parent's permission before downloading anything from the Web.)
- Take photos with a digital still camera, if available, and download the photos to the computer.



- After you have created your text and graphics, use a page assembly software application to make a digital layout. Procedures vary with different computers, software, and scanners, so you will need special instruction to assemble your layout on the computer. Check the manuals for the software application you use or ask your counselor for assistance.

Once you have completed the file of your layout, it is time to get the digital pasteup out of the computer—to *output* a copy of it. The *output device* you choose will depend on what is available and what printing process you plan to use for your job. Output devices include the following:

- The computer's printer, which prints a black image on white paper. You can use the black-and-white image like a traditional pasteup to make a high-contrast negative.

- An *imagesetter*, which makes a high-contrast piece of film as a process camera does.
- A *platesetter (digital platemaker)*, which makes a *printing plate* that can be put on the press.

In addition, some computers are connected directly to digital duplicators, electronic presses, high-speed laser printers, or other production output devices that can print large amounts of paper quickly. Read more about this in the chapter about the major printing processes, under “Electronic/Digital Printing.”

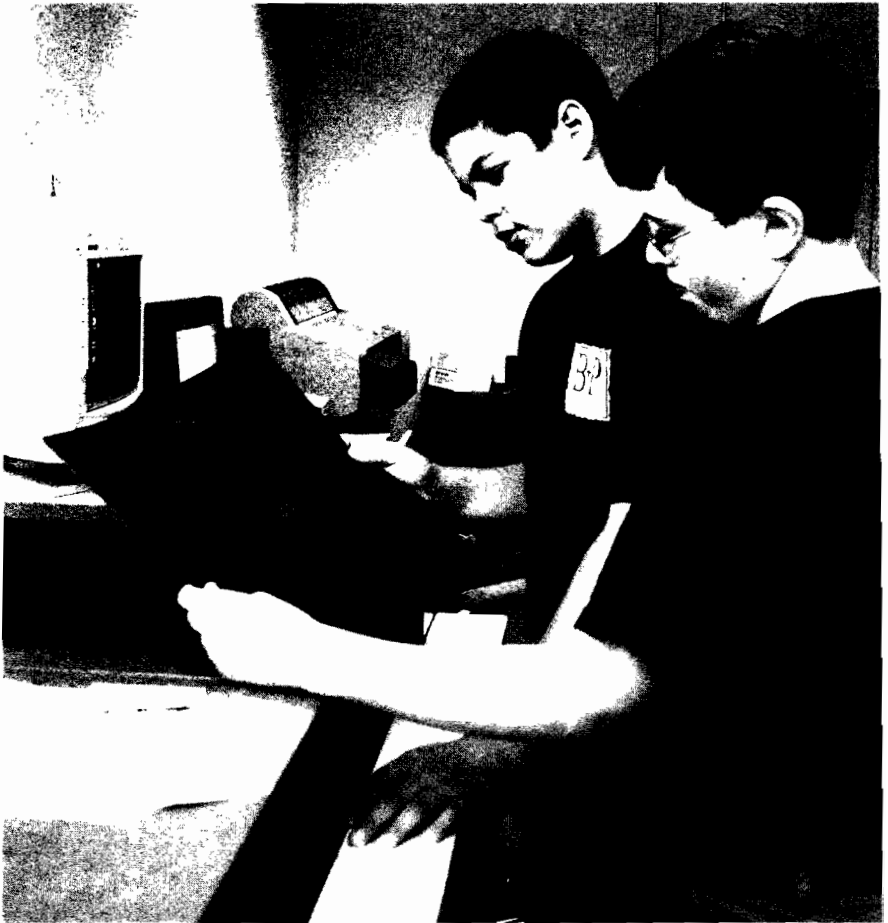

Digital platemaker

PROS

Training: Teaching the Cycle of the Cycle

INCREASING DISTRICT'S LEADERS

ARROWHEAD HONOR

THE BEST LEVEL OF PERFORMANCE AND THE BEST OF THE BEST FOR THE DISTRICT AND THE COUNTRY

HIGH SCOUT

in recognition of successful completion of all requirements for Scouting's highest rank

HANDBOOK

BOY SCOUTS OF AMERICA

The Patrol Leader Handbook

BOY SCOUTS OF AMERICA

PREPARE

SCOUTING...

VISION STATEMENT

The Boy Scouts of America is committed to the character, personal growth, leadership development and citizenship training of young people. Scouting will continue to...

Only young people responsible for their own lives and adventures.

Build in young people lifetime values and develop in them ethical character as expressed in the Scout Oath.

VENTURING AND YOUR YOUTH MINISTRY

Boy Scout REQUIREMENT 20

# Bindery and Finishing Operations

Bindery and finishing describes everything that takes place after the printed sheet leaves the press. (Some of these operations may also be done before printing.) These operations include binding (in a variety of methods), cutting or trimming, folding, collating (gathering), drilling or punching, stitching or stapling, padding, die-cutting, embossing, foil stamping, and perforating.

Small printing establishments complete these tasks on small, fairly simple pieces of equipment. Large printing establishments use larger and more sophisticated equipment for binding and finishing. Some of the equipment may be connected directly to the printing presses.

## Steps in handbinding a book

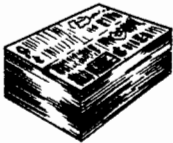

**STEP 1**—ASSEMBLING PRINTED SHEETS FOR THE BOOK



**STEP 3**—COLLATING (GATHERING) THE SIGNATURES IN THE CORRECT ORDER



**STEP 2**—FOLDING THE SHEETS INTO SIGNATURES

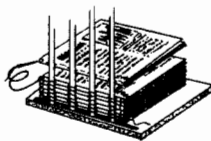

**STEP 4**—SEWING THE SIGNATURES TOGETHER

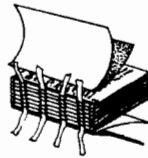

**STEP 5**—TIPPING ON (GLUING) THE ENDSHEETS



**STEPS 6 AND 7**—ROUNDING AND BACKING THE SPINE OF THE SEWN BOOK

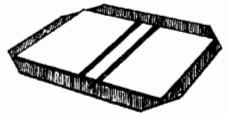

**STEP 8**—PREPARING THE COVER

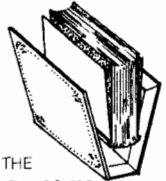

**STEP 9**—CASING-IN THE BOOK WITH THE COVER

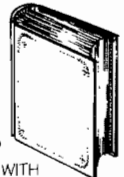

**STEP 10**—THE FINISHED BOUND BOOK WITH THE DECORATED COVER

## Key Bindery Operations

Bindery operations include case binding, perfect binding, and saddle stitching. *Case binding* is used for hardcover books such as textbooks and library books. Case binding can be done in several hand operations with simple equipment, but usually it is a mass-production operation of several steps with machines doing the work. The operations include folding multiple-page printed sheets into sections called *signatures*. These signatures have to be in multiples of four pages. The signatures are *collated* (gathered) in the proper order and sewn together. *Endsheets*, *headbands*, and a cover finish the book.

***Endsheets, or endpapers, are made of a stronger paper stock than the book pages and are placed at the beginning and end of the book. One leaf of the endsheets is pasted to the inside of the front or back cover. Headbands are narrow strips of cloth that are glued or sewn to the book at the top and bottom ends of the spine to provide a decorative edge.***

The cover also goes through several operations in its preparation. Your counselor can help you understand all these operations.

*Perfect binding* is used for paperback books and some magazines. Perfect binding also requires folding printed sheets into signatures and gathering them in order. The signatures are then clamped together and the folds ground to make a flat edge. The spine edge is glued (similar to padding—see the

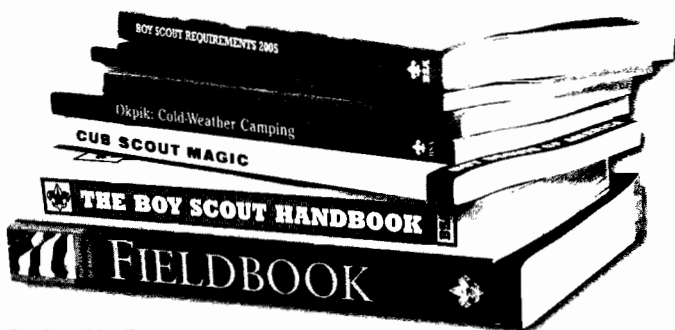

Perfect binding

explanation later in this chapter). A harder paper cover is wrapped around the glued pages, covering the front, spine, and back. Perfect-bound books are less costly than case-bound books, but they will not withstand bending or other hard use.

*Saddle stitching*, or stapling through the fold of a multiple-page publication, is another method of binding smaller pamphlets or booklets. Saddle stitching is used for smaller publications. Merit badge pamphlets are saddle stitched.



**Saddle stitching**

Other methods of binding generally are for single-sheet printed material, where each page is printed on a separate sheet. These binding methods are spiral, plastic comb, flat-stitching, and stapling.

Spiral and plastic comb binding require the pages to be punched with holes before the wire or plastic binding is applied. Stitching, a one-step operation using a thin wire called *spool wire*, is the oldest of the methods and the most economical. Stapling uses preformed staples. Books that have been stitched or stapled look the same.

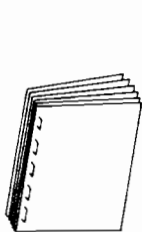

STAPLING



FLAT-STITCHING

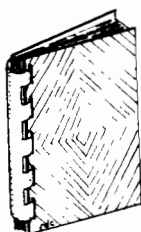

PLASTIC COMB

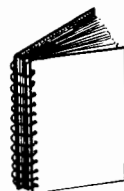

SPIRAL BINDING

## Making a Signature

If your printing project involves multiple-page composition, you should learn how to fold a sheet into a booklet format or signature. The most common project is simply folding an 8½-by-11-inch sheet in half, making four 5½-by-8½-inch pages—a typical four-page program with one fold.

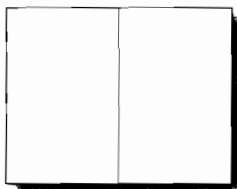

If you are producing more pages, fold another sheet to make four pages. Put the two signatures together for an eight-page booklet or program. Number the pages consecutively—now you have what printers call a *dummy*. It shows which pages will have a common fold when printed as two pages at a time. Make signatures for the dummy, for as many pages as you want.

Printing projects with different formats have more complicated folds. Two parallel folds (as if folding a letter) produce the dummy for a six-page brochure. (Each folded section, front and back, is considered one page.)

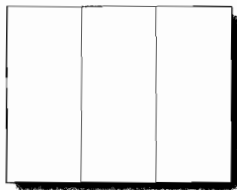

For a greeting card or announcement dummy, fold a sheet in half, turn it 90 degrees and then fold in half again. When you number the pages and unfold the sheet, you can see where the design for each page goes in the layout for the whole sheet.



## Other Bindery Operations

*Collating* means gathering the various printed sheets together in the correct order. In large operations, high-speed collating machines gather the pages in the proper sequence. In small operations, workers place stacks of each printed piece in order on a table that rotates, or they walk around a table assembling the pages in order.

*Padding* is the process for finishing notepads, memo pads, and forms that a customer wants in pad format. It starts with measured stacks of identically printed pages, divided into sections by cardboard sheets. The stack is put under pressure, and a padding compound is applied to coat one side of the stack. Usually two or three coats are applied, with drying time in between. After the final coat is dry, the stack is cut into individual pads.

Both *drilling* and *punching* create holes in the printed piece. Notebook paper and printed materials that will be put in ring binders are examples. A drill with a hollow center can go through several hundred sheets at a time, whereas a punch is good for only one to 10 sheets at a time.



Padding

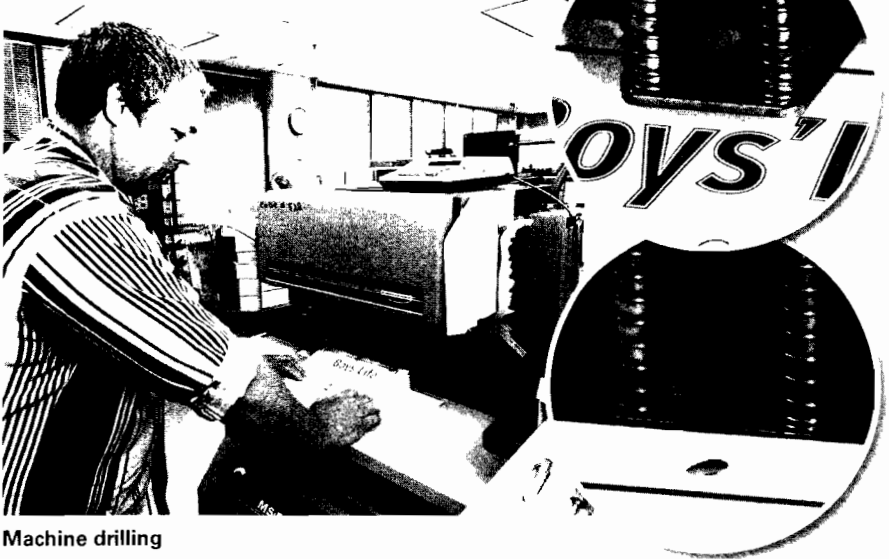

Machine drilling

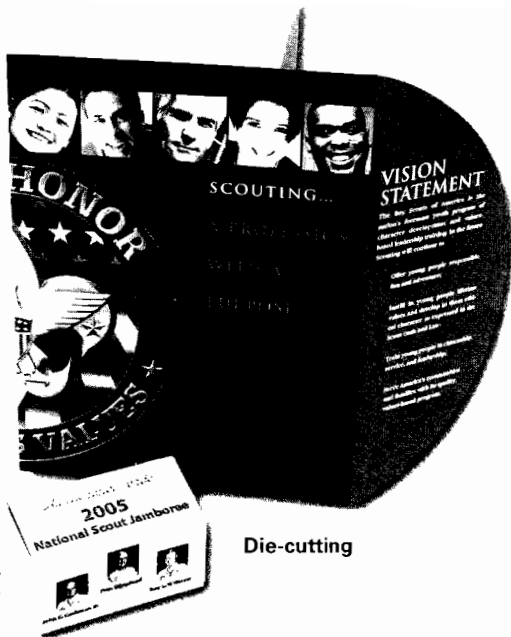

**Die-cutting**

Die-cutting, embossing, and foil stamping are three finishing operations especially designed for extra effects.

*Die-cutting* is a process in which a sharp-edged cutting tool (cutting die) cuts a design out of the printed material or cuts the whole printed piece into a shape. The cutting die is made especially for a particular design. If the cut is made within the printed area, each piece is cut separately. But if the shaping is done on the edges of the sheet (to make a memo pad shaped like a fish, for example), a die that can cut through several hundred sheets at a time is used.

*Embossing* is a process that uses an uninked die to raise in relief a design already printed on the paper surface.

*Foil stamping* is a special process that uses metallic foil instead of ink to create a metallic finish on a printed product, such as gold lettering on the cover of a leather-bound book.



**Embossing**



**Foil stamping**

*Folding* is the process of bending and creasing paper into the format for a particular printed item. A single sheet of paper can be machine folded if it is folded in straight folds and right-angle folds.

Greeting cards, maps, and letters folded to fit envelopes are examples of printed products requiring specific folding operations.

*Paper cutting* is a major operation that occurs before or after printing. Large sheets are cut to specific formats. The cutter can go through several hundred sheets accurately with one pass of the knife.

Most large paper cutters today are computer controlled for accurate cuts. The operator has only to position the paper stack for the right cut. All multiple-page books and pamphlets have to be *trimmed* on three sides so the edges will be smooth. In large printing operations, trimming is part of the overall binding process, either as an *in-line operation* (performed on the press) or on a special trimmer. For small jobs, this operation could be done on a regular paper cutter.

*Perforating* is punching a line of tiny holes in the paper so it can be torn apart easily. Examples are coupons and ticket stubs. *Scoring* is creasing heavy papers so they will bend cleanly,

without cracking or creasing the paper.

All finishing and binding operations can be done as small operations, with each step handled on a special piece of equipment. However, most printing processes today are highly automated, with several operations combined.



**Folding**

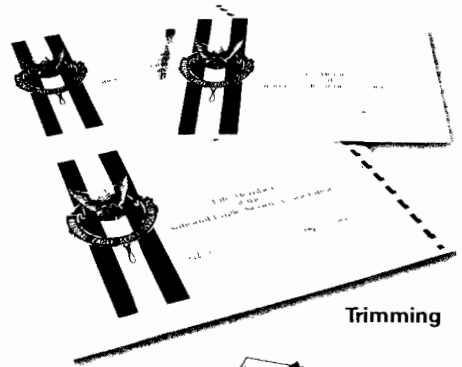

**Trimming**

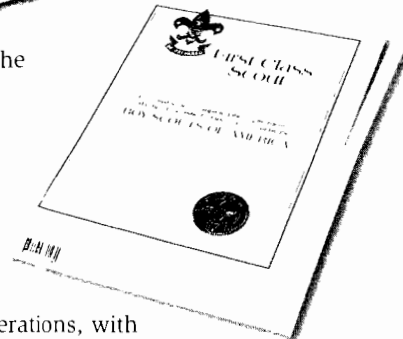

**Perforating**



**Scoring**

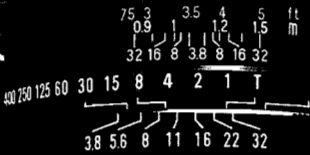
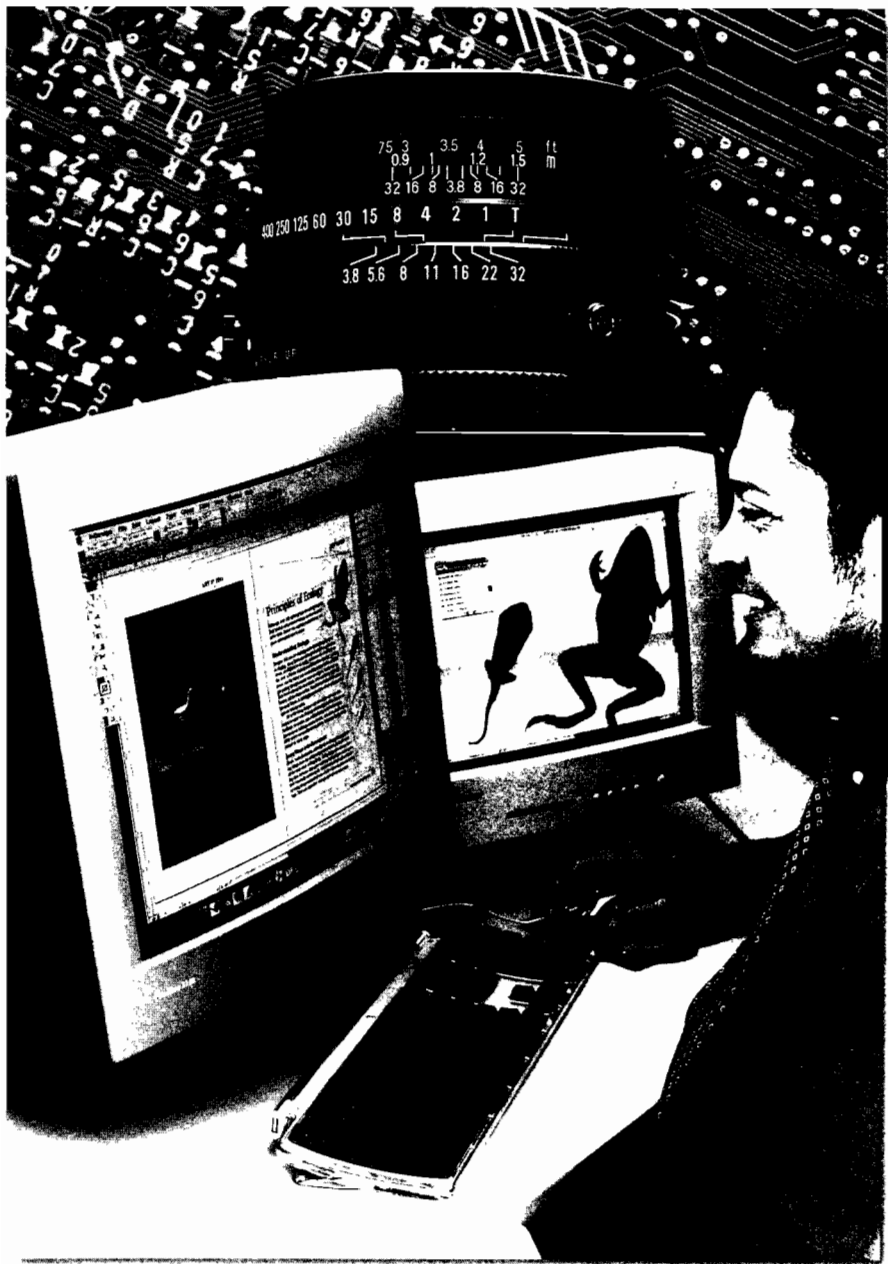

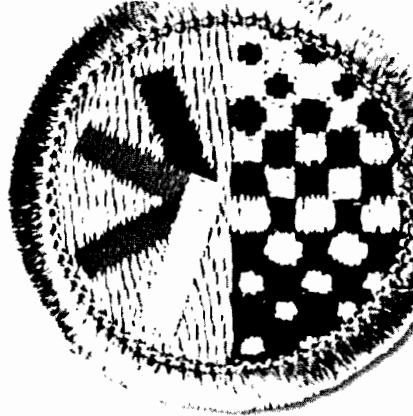

# Careers in the Graphic Arts

Maybe you are an innovative artist. Or maybe you are a computer wizard. You might be great with machinery. Or you like the idea of running a business that turns out beautifully printed books or magazines. Maybe you have the kind of scientific mind that can answer the challenges of printing on new types of surfaces. Or you might like to be one of the few artisans carrying on the art of binding books by hand.

The graphic arts industry has many different career areas, each needing people with special aptitudes and talents. Most careers require specialized training, education beyond high school, or an apprenticeship program.

Some of the major parts of the printing industry involve publishing and printing newspapers, magazines, and books. Other large segments of the business include commercial printing, package printing, and business forms printing.

The industry has seen tremendous changes because of developments in computer technology, and more changes are ahead. If you are thinking about a graphic arts career, be sure to seek advice from people who currently work in the business. They can tell you about the latest technology and the newest opportunities in the field.

When you work on your printing project for the Graphic Arts merit badge, you may do everything for the job, developing the idea and continuing through the entire printing process. But in the printing industry, it is common for a person to specialize in one area.

Requirement 7 asks you to tell how to prepare for three career opportunities in the graphic arts. Ask your merit badge counselor or a high school guidance counselor about educational preparation. Contact local schools and colleges to learn about their graphic arts programs. Also, you can check the

library for books on careers. Some books are listed in the resources section at the end of this pamphlet.

If you decide on a career in graphic arts, talk to your school guidance counselor about the courses you should take in high school. Science and computer courses may help you prepare, and you may be able to take graphic arts courses at your high school or a local vocational/technical school. Check the entrance requirements for the program you are considering entering after high school.

Many scholarships are available for students interested in a graphic arts career. Nearly all of the scholarships are for students going on to post-secondary education. For scholarship information, see the references at the end of this booklet, ask your guidance counselor, or ask the staff in the graphic arts program at the college or technical school that interests you.

Some post-secondary programs teach technology, some prepare students for management positions, and others train students for teaching the graphic arts.

Here are a few brief profiles of the many career opportunities in the graphic arts.

## The Management Area

A college degree in business and a thorough knowledge of printing practices and equipment is an excellent background for some of the management positions in a printing plant.



**Plant Manager.** To be a plant manager, you need to be skilled at working with people. A plant manager coordinates printing activities by directing supervisors in all departments. Plants often hire people with engineering degrees for this position.

# Opportunities in Graphic Arts Communications

**If you are interested in: Consider these graphic arts occupations:**

Accounting	Accountant, comptroller, cost clerk
Art	Art director, commercial artist, graphic designer, illustrator, layout artist
Chemistry and physics	Platemaker; research and development for ink, paper, chemicals
Computers	Computer graphics artist, computer photo editor, graphic designer, hardware or software designer for the graphic arts, prepress specialist, imaging specialist
Electronics	Camera operator, scanner operator, press operator
Engineering	Electronic engineer, industrial or mechanical engineer, time study technician
Language	Proofreader, copy editor, editor, typesetter, writer
Mathematics	Printing estimator
Mechanics	Bindery technician, press operator
Personnel	Employment manager, human resources director
Photography	Commercial photographer, photo offset camera operator
Precision work	Lithographic platemaker, lithographic stripper, pasteup artist, production manager
Safety	Safety manager
Sales	Printing sales representative
Teaching	Graphic arts instructor, high school or college level

**Printing Sales Representative.** A printing sales representative contacts potential customers and sells them the company's printing services. A successful printing sales representative knows the plant's capabilities and advises customers about printing decisions. The sales manager trains and supervises the sales representatives.

**Printing Estimator.** A printing estimator looks at *specifications* for a printing job, decides on a production plan for it, and estimates the cost for the potential customer. A good way to prepare for a career as a printing estimator is to get experience working in various departments in the company, so you learn what different types of printing jobs require.

**Customer Service Representative.** If you work as a customer service representative, you will track a customer's printing job through all the plant's departments and serve as a contact between the company and the customer.

*Printing specifications, or specs, are the physical descriptions that define how a job will look (such as the number of pages, the size of the piece, and the type of paper it will be printed on) and the processes necessary to create the finished piece (such as the type of printing process and the bindery operations needed).*





## The Art Area

Commercial art is a broad category that includes many kinds of artists who work on graphic communications materials. Commercial artists may work for a printing company, another type of business, an advertising agency, or a graphic design studio. Or they may freelance. A *freelancer* works independently, accepting assignments from various businesses, agencies, and other sources.

To prepare for a career in commercial art, look for programs at colleges, universities, and art institutes that focus on commercial art, graphic design, and advertising art. Courses are likely to include art, design principles, and computer-assisted design (CAD).



**Graphic Designer.** A graphic designer develops the concept and plans the appearance of materials such as ads, brochures, annual reports, packaging, labels, signs, company logos, and magazines. Designers know how to create good designs and typography, and how to make creative and effective use of different kinds of art media.

**Layout Artist.** A layout artist creates the rough sketch and also may prepare the comprehensive. In smaller companies, one person might be both the graphic designer and the layout artist.

**Pasteup Artist.** A pasteup artist combines type and art in a pasteup or works with a computer to prepare a digital pasteup.

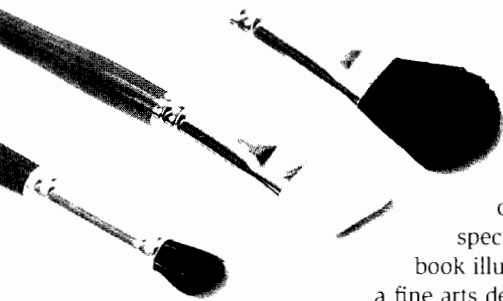

**Illustrator.** An illustrator produces the finished illustrations for books, ads, greeting cards, or other print materials. Some illustrators specialize in one area, such as children's book illustration. Book illustrators often have a fine arts degree in drawing or painting.

Some artists have skills in all these areas, making them valuable employees in smaller advertising agencies and printing companies.

## The Prepress Area

Some high schools offer courses in printing, but most prepress occupations require extensive training after high school. Look for colleges, universities, and vocational/technical schools with programs that may be called graphic arts, graphic communications, or printing.

To train for some positions, high school graduates 18 or older can apply for apprenticeships. Apprentices learn by working in a printing plant and, in some cases, by completing a correspondence course.

Although the printing industry is still growing, changing technology and automation have slowed the growth in the number of prepress and bindery career opportunities, but there is a new and growing need for press operators in all printing processes.

The following occupations are just a few of many prepress opportunities:

**Prepress Workflow Coordinator.** A prepress workflow coordinator handles the digital files of a printed job from the time they are received from the customer to the time the plates are made for the job.

**Platemaking Specialist.** A platemaking specialist makes printing plates or stencils from digital files or films.

**Digital Imaging Specialist.** A digital imaging specialist creates and adjusts digital photos and pictures on a computer and then combines photos and images with type into a final digital layout.

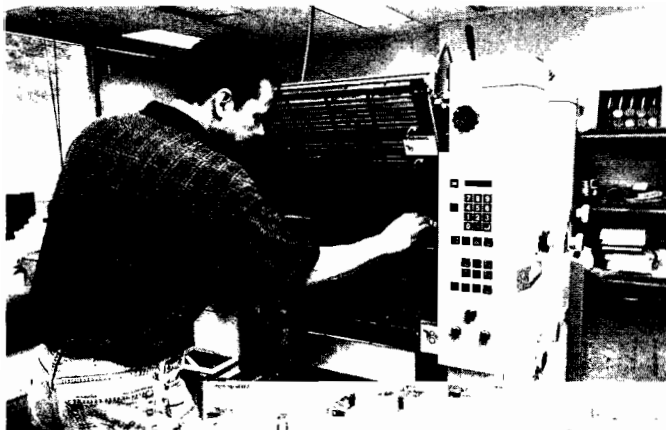

## The Pressroom Area

High school courses in chemistry, physics, computer science, and print shop will help prepare for the next level of education.

Press operator apprenticeships, where they are available, last two to five years, depending on the type of press involved. People applying for positions as press assistants need at least a high school diploma. In a small print shop with simple equipment, on-the-job training may be possible. There are many pressroom opportunities, depending on the different types of printing being done.

**Printing Press Operator.** A printing press operator prepares, maintains, and operates printing presses. The operator also installs printing plates on presses, loads paper, adjusts ink flow, and checks print quality. With a computer-controlled press, the operator monitors the printing process and makes adjustments at a control panel.



**Press Assistant.** A press assistant works with the press operator. An assistant may be required to start with small duplicator machines and work up to the large multicolor presses.

## The Bindery Area

Most bindery workers are trained on the job. Bindery positions require good mechanical skills, electronic systems experience, good coordination, and the ability to work quickly. Most finishing and bindery positions are entry level, unless the employee is a specialized setup person for the machines. In smaller graphic arts shops, many people start in the binding and finishing area and progress to printing, if these functions are all contained in one plant.

**Bindery Supervisor.** A bindery supervisor coordinates operations in the bindery, schedules jobs, and supervises and trains workers.



**Bindery Worker.** A bindery worker may prepare and tend one or more automated machines that do cutting, scoring, folding, stitching, taping, and gluing. In large binderies, the work is done on an assembly line, with workers performing one or two types of tasks.

**Perfect-Binder Setter.** A perfect-binder setter sets up and controls a binding machine that gathers magazine or book signatures, glues them, and adds the cover to magazines or paperback books.

**Handbound Bookbinder.** A bookbinder handbinds books—usually working on special editions and custom binding—and repairs old and rare books. Bookbinders learn by training with the relatively few experts in the field.

**Distribution Specialist.** A distribution specialist coordinates the mailing and shipping of printed products and uses computers to organize mailings and to control addressing and mailing equipment. Working as a distribution specialist is an important position because it carries the responsibility of making sure magazines, catalogs, billing statements, and direct mailings get to customers correctly and on time.

# Graphic Arts Resources

## Scouting Literature

*American Business, Art, Communications, Computers, Journalism, and Photography*: merit badge pamphlets

## Books

Adam, Robert, and Carol Robertson. *Screenprinting: The Complete Water-Based System*. Thames and Hudson, 2004.

Adams, J. Michael, and Penny Ann Dolin. *Printing Technology*. Thomson Delmar Learning, 2001.

Blake, Kathy. *Handmade Books: A Step-by-Step Guide to Crafting Your Own Books*. Little, Brown, & Co., 1997.

Brookfield, Karen. *Eyewitness: Book*. Dorling Kindersley Publishing, 2000.

Bruno, Michael H., ed. *Pocket Pal: A Graphic Arts Production Handbook*. Graphic Arts Technical Foundation, 2000.

Ernst-Moriarty, Sandra B. *ABCs of Typography: A Practical Guide to the Art and Science of Typography*. Art Direction Book Company, 1990.

Fleishman, Michael. *Starting Your Career as a Freelance Illustrator or Graphic Designer*. Watson-Guptill Publications, 2001.

Friedl, Friedrich. *Typography: An Encyclopedic Survey of Type Design and Techniques Throughout History*. Black Dog & Levanthal, 1998.

Gatter, Mark. *Getting It Right in Print: Digital Prepress for Graphic Designers*. Harry N. Abrams, 2005.

Goldfarb, Roz. *Careers by Design: A Business Guide for Graphic Designers*. Allworth Press, 2002.

Gordon, Barbara. *Opportunities in Commercial Art and Graphic Design Careers*. McGraw-Hill, 2003.

Graham, Lisa. *Basics of Design Layout and Typography for Beginners*. Thomson Delmar Learning, 2001.

Griffiths, Antony. *Prints and Printmaking: an Introduction to the History and Techniques*. University of California Press, 1996.

Heller, Steven, and Teresa Fernandes. *Becoming a Graphic Designer: A Guide to Careers in Design*. John Wiley & Sons, 2002.

- Lumgair, Christopher. *Teach Yourself Desktop Publishing*. McGraw-Hill, 2001.
- Olmert, Michael, and Christopher De Hamel. *The Smithsonian Book of Books*. Smithsonian Books, 2003.
- Sidles, Constance. *Graphic Designer's Digital Printing and Prepress Handbook*. Rockport Publishers, 2001.
- White, Alexander. *The Elements of Graphic Design: Space, Unity, Page Architecture and Type*. Watson-Guptill, 2002.
- Williams, Robin. *The Non-Designer's Design Book*. Peachpit Press, 2003.
- . *The Non-Designer's Type Book*. Peachpit Press, 2005.
- Wilson, Daniel G. *Lithography Primer*. Gaftpress, 1997.

## Web Sites

### Graphic Comm Central

Web site: <http://www.TechEd.vt.edu/gcc>  
 This portal site for graphic communications education and training includes links to lessons and activities as well as career resources and virtual tours of printing plants.

### My Design Primer Printing Topics

Web site:  
<http://www.mydesignprimer.com/printing/50000.html>  
 This site features a range of essays on electronic graphic design topics.

## Print and Graphics Scholarship Foundation

Web site: <http://www.gain.net/employment/scholarships.html>  
 This online resource provides information about applying for college scholarships to study graphic communications.

## Vocational Information Center: Graphic Arts and Printing Career Resources

Web site: <http://www.khake.com/page27.html>  
 This site provides a comprehensive listing of links to descriptions of hundreds of career opportunities in the fields of graphic arts and printing.

## Acknowledgments

The Boy Scouts of America thanks the following members of the International Graphic Arts Education Association who contributed their time and expertise to update this new edition of the *Graphic Arts* merit badge pamphlet: A. Thomas Loch, John Craft, Dave Hayes, James Nelson, Michael Stinnett, and James Tenoria.

We appreciate Quebecor World, Dallas, Texas, and Barron Litho, Fort Worth, Texas, for allowing us to photograph their facilities for some of the photos used in this pamphlet.

The BSA gratefully acknowledges the following individuals who contributed to the 1998 edition of the *Graphic Arts* merit badge pamphlet, upon which this new edition is closely based: Chuck Brown, Michael Cermak, Kevin Chederquist, Kenneth Kulakowsky, Linda Laney, Warren Mack, Glen Moerdyk, Edward Prahll, Robert Rateno,

Thomas Vogt, Gary Walton, Mark Watanabe, and John Wilson.

We appreciate the American Library Association for its assistance with updating the resources section of this pamphlet. The ALA has a special committee charged with assisting the BSA with its merit badge pamphlet series in this capacity, and it does so very effectively.

### **Photo and Illustration Credits**

Collection of the Hebraic Section,  
Library of Congress, Washington,  
D.C., courtesy—page 10 (*left*)

Comstock Inc., ©2003—page 39  
(*right top, right bottom*)

©Photos.com—pages 8, 9, 10 (*right*),  
15, 16, 27, 40, 51 (*background*), 57  
(*all*), 58, 62 (*both*), 76 (*background,*  
*inset*), 82, 83 (*bottom*), 84, and 85

Pierpont Morgan Library, New York;  
PML 818—page 14

Hebraic Section, Library of Congress,  
Washington, D.C., courtesy—page 12

All other photos and illustrations not  
mentioned above are the property of  
or are protected by the Boy Scouts  
of America.

Stephen Mark Hernandez—page 29

John McDearmon—pages 20, 22, and 38

Randy Piland—page 39 (*left*)